

XL Series Meters

**XL15 • 20 • 25 • 30
40 • 50 • 60**



USER Manual

XL 15 Meter: Table of Contents

Introduction	1	pH Operation	
Unpacking the Meter	2	About pH Measurement.....	111
XL Series Meters Specifications	3-4	Standardizing	
		with Auto Buffer Recognition	112
		Standardizing	
		with Manual Buffer Recognition.....	113
		Temperature Standardization	114
		pH Measurement with Auto Read	
		On And Off.....	115
		Graphing Function	116
Getting Started		mV Operation	
XL Series Meters Connectors	5-8	About mv Measurement	117
Start-up and Shut down procedures	9	Absolute mv Measurement.....	118
pH and Ion probes	11-12	Relative mv Standardization and Measurement.....	118
		Graphing Function	119
		Warranty	160
		Compliance	160
Using the XL Series Meter		Appendix	
Touch Screen Operation.....	15-16	Setting the XL Series Meters User Profiles	161-163
Screen Contrast Adjustment.....	16	XL Series Meters	
Using The Stylus	17	Factory Default Settings	164-166
Stylus Calibration	17	XL Series Meters	
Setting Time And Date.....	18	Print Function	167-168
On-Screen Keyboard	19	Background and Color Adjustment.....	169-170
Expansion Cards	20	Determining Isopotential Points	
Connecting To The Internet	21	Experimentally	171
Button Functions	22-25	pH Theory.....	172-175
Channel Assignment.....	26-27	Replacement Parts	185-187
Display Setup.....	28		
pH Setup			
pH Setup Screen And Function Buttons	29		
Access pH Setup	30		
Set Sample ID#.....	31		
Select Buffer Group	32		
Select Buffer Recognition	33		
Select Auto Read Mode	33		
Set Ph Stability Criteria	34		
Set Default Temperature.....	34		
Set Isopotential Point	35		
Set Alarm Limits.....	35		
Set Print Criteria.....	36		
Set Data Storage Criteria.....	37		
Set Display Criteria Setup.....	38		
View Stored Data	39-40		
mV Setup			
mv Setup Screen And Function Buttons	41		
Access mv Setup	42		
Set Sample ID#.....	43		
Set Alarm Limits.....	44		
Set Print Criteria Setup	45		
Set Data Storage Criteria.....	46		
Set Display Criteria	47		
View Stored Data	48-49		

68X374204 Rev 5 Jan'08

XL 20 Meter: Table of Contents

Introduction	1		
Unpacking the Meter	2		
XL Series Meters Specifications	3-4		
Getting Started			
XL Series Meters Connectors	5-8		
Start-up and Shut down procedures	9		
pH and Ion Probes	11-12		
Conductivity Cells	13		
Using the XL Series Meter			
Touch Screen Operation	15-16		
Screen Contrast Adjustment	16		
Using The Stylus	17		
Stylus Calibration	17		
Setting Time And Date	18		
On-Screen Keyboard	19		
Expansion Cards	20		
Connecting To The Internet	21		
Button Functions	22-25		
Channel Assignment	26-27		
Display Setup	28		
pH Setup			
pH Setup Screen And Function Buttons	29		
Access pH Setup	30		
Set Sample ID#	31		
Select Buffer Group	32		
Select Buffer Recognition	33		
Select Auto Read Mode	33		
Set Ph Stability Criteria	34		
Set Default Temperature	34		
Set Isopotential Point	35		
Set Alarm Limits	35		
Set Print Criteria	36		
Set Data Storage Criteria	37		
Set Display Criteria Setup	38		
View Stored Data	39-40		
mV Setup			
mv Setup Screen And Function Buttons	41		
Access mv Setup	42		
Set Sample ID#	43		
Set Alarm Limits	44		
Set Print Criteria Setup	45		
Set Data Storage Criteria	46		
Set Display Criteria	47		
View Stored Data	48-49		
Conductivity Setup			
Conductivity Setup Screen And Function Buttons	81		
Access Conductivity Setup	82		
Set Sample ID#	83		
Conductivity Standards	84		
Select Standard Recognition	84		
Select Stable Indicator	85		
Select Auto Read Mode	85		
Select Cell Constant	85		
Set Default Temperature	86		
Set Reference Temperature	86		
Set Temperature Coefficient	87		
Set Alarm Limits	87		
Set Print Criteria	88		
Set Data Storage Criteria	89		
Set Display Criteria	90		
View Stored Data	91-92		
Resistivity Setup			
Resistivity Setup Screen and Function Buttons	93		
Access Resistivity Setup	94		
Set Sample ID#	95		
Set Calibration Points	95		
Select Stable Indicator	95		
Select Auto Read Mode	95		
Select Cell Constant	96		
Set Default Temperature	96		
Set Reference Temperature	96		
Set Temperature Coefficient	96		
Set Alarm Limits	97		
Set Print Criteria	97		
Set Data Storage Criteria	98		
Set Display Criteria	98		
View Stored Data	98		
TDS (Total Dissolved Solids) Setup			
TDS Setup Screen and Function Buttons	99		
Access TDS Setup	100		
Set Sample ID#	101		
Set Calibration Points	101		
Select Stable Indicator	101		
Select Auto Read Mode	101		
Select Cell Constant	102		
Set TDS Factor	102		
Set Default Temperature	102		
Set Reference Temperature	102		
Set Temperature Coefficient	103		
Set Alarm Limits	103		
Set Print Criteria	103		
Set Data Storage Criteria	104		
Set Display Criteria	104		
View Stored Data	104		
Salinity Setup			
Salinity Setup Screen and Function Buttons	105		
Access Salinity Setup	106		
Set Sample ID#	107		
Set Calibration Points	107		
Select Stable Indicator	107		
Select Auto Read Mode	107		
Select Cell Constant	108		
Set Default Temperature	108		
Set Reference Temperature	108		
Set Temperature Coefficient	108		
Set Alarm Limits	109		
Set Print Criteria	109		
Set Data Storage Criteria	110		
Set Display Criteria	110		
View Stored Data	110		

XL 20 Meter: Table of Contents

pH Operation			
About pH Measurement.....	110		
Standardizing			
with Auto Buffer Recognition.....	112		
Standardizing			
with Manual Buffer Recognition.....	113		
Temperature Standardization.....	114		
pH Measurement with Auto Read			
On And Off.....	115		
Graphing Function.....	116		
mV Operation			
About mv Measurement.....	117		
Absolute mv Measurement.....	118		
Relative mv Standardization and Measurement.....	118		
Graphing Function.....	119		
Conductivity Operation			
About Conductivity Measurement.....	154		
Standardizing.....	155-156		
With Auto Buffer Recognition.....	155		
With Manual Buffer Recognition.....	156		
Temperature Standardization.....	157		
Conductivity Measurement.....	158		
Graphing Function.....	159		
Warranty		160	
Compliance		160	
Appendix			
Setting the XL Series Meters User Profiles.....	161-163		
XL Series Meters			
Factory Default Settings.....	164-166		
XL Series Meters			
Print Function.....	167-168		
Background and Color Adjustment.....	169-170		
Determining Isopotential Points			
Experimentally.....	171		
pH Theory.....	172-175		
Replatinization.....	181		
Conductivity Theory.....	182-184		
Replacement Parts.....	185-187		

XL 25 Meter: Table of Contents

Introduction	1		
Unpacking the Meter	2		
XL Series Meters Specifications	3-4		
Getting Started			
XL Series Meters Connectors	5-8		
Start-up and Shut down procedures	9		
pH and Ion Probes	11-12		
Using the XL Series Meter			
Touch Screen Operation	15-16		
Screen Contrast Adjustment	16		
Using the Stylus	17		
Stylus Calibration	17		
Setting Time and Date	18		
On-Screen Keyboard	19		
Expansion Cards	20		
Connecting To the Internet	21		
Button Functions	22-25		
Channel Assignment	26-27		
Display Setup	28		
pH Setup			
pH Setup Screen And Function Buttons	29		
Access pH Setup	30		
Set Sample ID#	31		
Select Buffer Group	32		
Select Buffer Recognition	33		
Select Auto Read Mode	33		
Set Ph Stability Criteria	34		
Set Default Temperature	34		
Set Isopotential Point	35		
Set Alarm Limits	35		
Set Print Criteria	36		
Set Data Storage Criteria	37		
Set Display Criteria Setup	38		
View Stored Data	39-40		
mV Setup			
mv Setup Screen And Function Buttons	41		
Access mv Setup	42		
Set Sample ID#	43		
Set Alarm Limits	44		
Set Print Criteria Setup	45		
Set Data Storage Criteria	46		
Set Display Criteria	47		
View Stored Data	48-49		
Ion Setup			
Ion Setup Screen and Function Buttons	50		
Access Ion Setup	51		
Set Sample ID#	52		
Ion Method	53		
Select Electrode Type	54		
Select Measurement Units	54		
Select Auto Read Mode	55		
Select Ion Stability Criteria	55		
Set Default Temperature	56		
Set Temperature Compensation	57		
Set Isopotential Point	57		
Set Alarm Limits	57		
Set Print Criteria	58		
Set Data Storage Criteria	59		
Set Display Criteria	60		
View Stored Data	61-62		
		pH Operation	
		About pH Measurement	110
		Standardizing	
		with Auto Buffer Recognition	112
		Standardizing	
		with Manual Buffer Recognition	113
		Temperature Standardization	114
		pH Measurement with Auto Read	
		On And Off	115
		Graphing Function	116
		mV Operation	
		About mv Measurement	117
		Absolute mv Measurement	118
		Relative mv Standardization and Measurement	118
		Graphing Function	119
		Ion Operation	
		About Ion MEASUREMENT	120
		DIRECT READING METHODS	121-124
		Standardization: Direct Reading	
		with Standards	121
		Measurement: Direct Reading	
		with Standards	122
		Standardization: Direct Reading	
		with Blank Offset	123
		Measurement: Direct Reading	
		with Blank Offset	124
		INCREMENTAL METHODS	125-133
		Standardization: All Incremental Methods	125
		Measurement: Known Addition Method	126-127
		Measurement: Known Subtraction Method	128-129
		Measurement: Analate Addition Method	130-131
		Measurement: Analate Subtraction Method	132-133
		Graphing Function	134
		Warranty	160
		Compliance	160
		Appendix	
		Setting the XL Series Meters User Profiles	161-163
		XL Series Meters	
		Factory Default Settings	164-166
		XL Series Meters	
		Print Function	167-168
		Background and Color Adjustment	169-170
		Determining Isopotential Points	
		Experimentally	171
		pH Theory	172-175
		ISE Theory	176-179
		Replacement Parts	185-187

XL 30 Meter: Table of Contents

Introduction	1		
Unpacking the Meter	2		
XL Series Meters Specifications	3-4		
Getting Started			
XL Series Meters Connectors	5-8		
Start-up and Shut down procedures	9		
Conductivity Cells	13		
Using the XL Series Meter			
Touch Screen Operation	15-16		
Screen Contrast Adjustment	16		
Using the Stylus	17		
Stylus Calibration	17		
Setting Time and Date	18		
On-Screen Keyboard	19		
Expansion Cards	20		
Connecting To the Internet	21		
Button Functions	22-25		
Channel Assignment	26-27		
Display Setup	28		
Conductivity Setup			
Conductivity Setup Screen And Function Buttons	81		
Access Conductivity Setup	82		
Set Sample ID#	83		
Conductivity Standards	84		
Select Standard Recognition	84		
Select Stable Indicator	85		
Select Auto Read Mode	85		
Select Cell Constant	85		
Set Default Temperature	86		
Set Reference Temperature	86		
Set Temperature Coefficient	87		
Set Alarm Limits	87		
Set Print Criteria	88		
Set Data Storage Criteria	89		
Set Display Criteria	90		
View Stored Data	91-92		
Resistivity Setup			
Resistivity Setup Screen and Function Buttons	93		
Access Resistivity Setup	94		
Set Sample ID#	95		
Set Calibration Points	95		
Select Stable Indicator	95		
Select Auto Read Mode	95		
Select Cell Constant	96		
Set Default Temperature	96		
Set Reference Temperature	96		
Set Temperature Coefficient	96		
Set Alarm Limits	97		
Set Print Criteria	97		
Set Data Storage Criteria	98		
Set Display Criteria	98		
View Stored Data	98		
TDS (Total Dissolved Solids) Setup			
TDS Setup Screen and Function Buttons	99		
Access TDS Setup	100		
Set SampleID#	101		
Set Calibration Points	101		
Select Stable Indicator	101		
Select Auto Read Mode	101		
Select Cell Constant	102		
Set TDS Factor	102		
Set Default Temperature	102		
Set Reference Temperature	102		
Set Temperature Coefficient	103		
Set Alarm Limits	103		
Set Print Criteria	103		
Set Data Storage Criteria	104		
Set Display Criteria	104		
View Stored Data	104		
Salinity Setup			
Salinity Setup Screen and Function Buttons	105		
Access Salinity Setup	106		
Set Sample ID#	107		
Set Calibration Points	107		
Select Stable Indicator	107		
Select Auto Read Mode	107		
Select Cell Constant	108		
Set Default Temperature	108		
Set Reference Temperature	108		
Set Temperature Coefficient	108		
Set Alarm Limits	109		
Set Print Criteria	109		
Set Data Storage Criteria	110		
Set Display Criteria	110		
View Stored Data	110		
Conductivity Operation			
About Conductivity Measurement	154		
Standardizing	155-156		
With Auto Buffer Recognition	155		
With Manual Buffer Recognition	156		
Temperature Standardization	157		
Conductivity Measurement	158		
Graphing Function	159		
Warranty	160		
Compliance	160		
Appendix			
Setting the XL Series Meters User Profiles	161-163		
XL Series Meters Factory Default Settings	164-166		
XL Series Meters Print Function	167-168		
Background and Color Adjustment	169-170		
Replatinization	181		
Conductivity Theory	182-184		
Replacement Parts	185-187		

XL 40 Meter: Table of Contents

Introduction	1	DO Operation	
Unpacking the Meter	2	STANDARDIZING	135-141
XL Series Meters Specifications	3-4	About DO Standardizing	135-136
		Automatic at One Point—% Saturation	137
		Automatic at Two Points—% Saturation	138
		Automatic at One Point—mg/L	139
		Manual at One Point—% saturation and mg/L	140
		Temperature Standardization	141
		MEASUREMENT	142-152
		About DO Measurement	142
		Auto Read ON and Auto Read OFF	142
		About BOD Measurement	143
		BOD Calculation Parameters	144
		Measurement of BOD of Sample	145
		Initial DO measurement for Sample	
		BOD calculation	146
		Measurement of BOD of Seed	147
		Initial DO measurement for Seed	
		BOD Calculation	147
		Final DO Measurement for Sample	
		BOD Calculation	148
		Final DO Measurement for Seed BOD Calculation .	149
		Editing Select View Screen	150
		OUR Measurement	151
		SOUR Measurement	152
		DO Graphing Function	153
		Warranty	160
		Compliance	160
		Appendix	
		Setting the XL Series Meters User Profiles	161-163
		XL Series Meters	
		Factory Default Settings	164-166
		XL Series Meters	
		Print Function	167-168
		Background and Color Adjustment	169-170
		DO Theory	180
		Replacement Parts	185-187
Getting Started			
XL Series Meters Connectors	5-8		
Start-up and Shut down procedures	10		
Dissolved Oxygen Probe	14		
Using the XL Series Meter			
Touch Screen Operation	15-16		
Screen Contrast Adjustment	16		
Using the Stylus	17		
Stylus Calibration	17		
Setting Time and Date	18		
On-Screen Keyboard	19		
Expansion Cards	20		
Connecting To the Internet	21		
Button Functions	22-25		
Channel Assignment	26-27		
Display Setup	28		
DO Setup			
DO Setup Screen and Function Buttons	63		
Access DO Setup	64		
Set Sample ID#	65		
Select Measurement Units	66		
Select Calibration Mode	66		
Select Stable Indicator	67		
Select Auto Read Mode	67		
Select Temperature Units	68		
Set Barometer	68		
Set Salinity	69		
Set Alarm Limits	69		
Set Print Criteria	70		
Set Data Storage Criteria	71		
Set Display Criteria Setup	72		
View Stored Data	73-74		
BOD Setup			
BOD Setup Screen and Function Buttons	75		
BOD Configuration	76		
OUR Setup			
OUR Setup Screen and Function Buttons	75		
OUR Configuration	78		
SOUR Setup			
SOUR Setup Screen And Function Buttons	79		
SOUR Configuration	80		

XL 50 Meter: Table of Contents

Introduction	1	Conductivity Setup	
Unpacking the Meter	2	Conductivity Setup Screen	
XL Series Meters Specifications	3-4	And Function Buttons	81
Getting Started		Access Conductivity Setup	82
XL Series Meters Connectors	5-8	Set Sample ID#	83
Start-up and Shut down procedures	9	Conductivity Standards	84
pH and Ion Probes	11-12	Select Standard Recognition	84
Conductivity Cells	13	Select Stable Indicator	85
Using the XL Series Meter		Select Auto Read Mode	85
Touch Screen Operation	15-16	Select Cell Constant	85
Screen Contrast Adjustment	16	Set Default Temperature	86
Using the Stylus	17	Set Reference Temperature	86
Stylus Calibration	17	Set Temperature Coefficient	87
Setting Time and Date	18	Set Alarm Limits	87
On-Screen Keyboard	19	Set Print Criteria	88
Expansion Cards	20	Set Data Storage Criteria	89
Connecting To the Internet	21	Set Display Criteria	90
Button Functions	22-25	View Stored Data	91-92
Channel Assignment	25-27	Resistivity Setup	
Display Setup	28	Resistivity Setup Screen and Function Buttons	93
pH Setup		Access Resistivity Setup	94
pH Setup Screen And Function Buttons	29	Set Sample ID#	95
Access pH Setup	30	Set Calibration Points	95
Set Sample ID#	31	Select Stable Indicator	95
Select Buffer Group	32	Select Auto Read Mode	95
Select Buffer Recognition	33	Select Cell Constant	96
Select Auto Read Mode	33	Set Default Temperature	96
Set Ph Stability Criteria	34	Set Reference Temperature	96
Set Default Temperature	34	Set Temperature Coefficient	96
Set Isopotential Point	35	Set Alarm Limits	97
Set Alarm Limits	35	Set Print Criteria	97
Set Print Criteria	36	Set Data Storage Criteria	98
Set Data Storage Criteria	37	Set Display Criteria	98
Set Display Criteria Setup	38	View Stored Data	98
View Stored Data	39-40	TDS (Total Dissolved Solids) Setup	
mV Setup		TDS Setup Screen and Function Buttons	99
mv Setup Screen And Function Buttons	41	Access TDS Setup	100
Access mv Setup	42	Set SampleID#	101
Set Sample ID#	43	Set Calibration Points	101
Set Alarm Limits	44	Select Stable Indicator	101
Set Print Criteria Setup	45	Select Auto Read Mode	101
Set Data Storage Criteria	46	Select Cell Constant	102
Set Display Criteria	47	Set TDS Factor	102
View Stored Data	48-49	Set Default Temperature	102
Ion Setup		Set Reference Temperature	102
Ion Setup Screen and Function Buttons	50	Set Temperature Coefficient	103
Access Ion Setup	51	Set Alarm Limits	103
Set Sample ID#	52	Set Print Criteria	103
Ion Method	53	Set Data Storage Criteria	104
Select Electrode Type	54	Set Display Criteria	104
Select Measurement Units	54	View Stored Data	104
Select Auto Read Mode	55	Salinity Setup	
Select Ion Stability Criteria	55	Salinity Setup Screen and Function Buttons	105
Set Default Temperature	56	Access Salinity Setup	106
Set Temperature Compensation	57	Set Sample ID#	107
Set Isopotential Point	57	Set Calibration Points	107
Set Alarm Limits	57	Select Stable Indicator	107
Set Print Criteria	58	Select Auto Read Mode	107
Set Data Storage Criteria	59	Select Cell Constant	108
Set Display Criteria	60	Set Default Temperature	108
View Stored Data	61-62	Set Reference Temperature	108
		Set Temperature Coefficient	108
		Set Alarm Limits	109
		Set Print Criteria	109
		Set Data Storage Criteria	110
		Set Display Criteria	110
		View Stored Data	110

XL 50 Meter: Table of Contents

pH Operation			
About pH Measurement	110		
Standardizing			
with Auto Buffer Recognition	112		
Standardizing			
with Manual Buffer Recognition	113		
Temperature Standardization	114		
pH Measurement with Auto Read			
On And Off	115		
Graphing Function	116		
mV Operation			
About mv Measurement	117		
Absolute mv Measurement	118		
Relative mv Standardization and Measurement	118		
Graphing Function	119		
Ion Operation			
About Ion MEASUREMENT	120		
DIRECT READING METHODS	121-124		
Standardization: Direct Reading			
with Standards	121		
Measurement: Direct Reading			
with Standards	122		
Standardization: Direct Reading			
with Blank Offset	123		
Measurement: Direct Reading			
with Blank Offset	124		
INCREMENTAL METHODS	125-133		
Standardization: All Incremental Methods	125		
Measurement: Known Addition Method	126-127		
Measurement: Known Subtraction Method	128-129		
Measurement: Analate Addition Method	130-131		
Measurement: Analate Subtraction Method	132-133		
Graphing Function	134		
Conductivity Operation			
About Conductivity Measurement	154		
Standardizing	155-156		
With Auto Buffer Recognition	155		
With Manual Buffer Recognition	156		
Temperature Standardization	157		
Conductivity Measurement	158		
Graphing Function	159		
Warranty		160	
Compliance		160	
Appendix			
Setting the XL Series Meters User Profiles	161-163		
XL Series Meters			
Factory Default Settings	164-166		
XL Series Meters			
Print Function	167-168		
Background and color adjustment	169-170		
Determining Isopotential Points			
Experimentally	171		
pH Theory	172-175		
ISE Theory	176-179		
Replatinization	181		
Conductivity Theory	182-184		
Replacement Parts	185-187		

XL 60 Meter: Table of Contents

Introduction	1	DO Setup	
Unpacking the Meter	2	DO Setup Screen and Function Buttons	63
XL Series Meters Specifications	3-4	Access DO Setup	64
Getting Started		Set Sample ID#	65
XL Series Meters Connectors	5-8	Select Measurement Units	66
Start-up and Shut down procedures	9	Select Calibration Mode	66
pH and Ion Probes	11-12	Select Stable Indicator	67
Conductivity Cells	13	Select Auto Read Mode	67
Dissolved Oxygen Probe	14	Select Temperature Units	68
Using the XL Series Meter		Set Barometer	68
Touch Screen Operation	15-16	Set Salinity	69
Screen Contrast Adjustment	16	Set Alarm Limits	69
Using the Stylus	17	Set Print Criteria	70
Stylus Calibration	17	Set Data Storage Criteria	71
Setting Time and Date	18	Set Display Criteria Setup	72
On-Screen Keyboard	19	View Stored Data	73-74
Expansion Cards	20		
Connecting To the Internet	21	BOD Setup	
Button Functions	22-25	BOD Setup Screen and Function Buttons	75
Channel Assignment	26-27	BOD Configuration	76
Display Setup	28		
		OUR Setup	
pH Setup		OUR Setup Screen and Function Buttons	77
pH Setup Screen And Function Buttons	29	OUR Configuration	78
Access pH Setup	30		
Set Sample ID#	31	SOUR Setup	
Select Buffer Group	32	SOUR Setup Screen And Function Buttons	79
Select Buffer Recognition	33	SOUR Configuration	80
Select Auto Read Mode	33		
Set Ph Stability Criteria	34	Conductivity Setup	
Set Default Temperature	34	Conductivity Setup Screen	
Set Isopotential Point	35	And Function Buttons	81
Set Alarm Limits	35	Access Conductivity Setup	82
Set Print Criteria	36	Set Sample ID#	83
Set Data Storage Criteria	37	Conductivity Standards	84
Set Display Criteria Setup	38	Select Standard Recognition	84
View Stored Data	39-40	Select Stable Indicator	85
		Select Auto Read Mode	85
		Select Cell Constant	85
		Set Default Temperature	86
		Set Reference Temperature	86
		Set Temperature Coefficient	87
		Set Alarm Limits	87
		Set Print Criteria	88
		Set Data Storage Criteria	89
		Set Display Criteria	90
		View Stored Data	91-92
		Resistivity Setup	
mV Setup		Resistivity Setup Screen and Function Buttons	93
mv Setup Screen And Function Buttons	41	Access Resistivity Setup	94
Access mv Setup	42	Set Sample ID#	95
Set Sample ID#	43	Set Calibration Points	95
Set Alarm Limits	44	Select Stable Indicator	95
Set Print Criteria Setup	45	Select Auto Read Mode	95
Set Data Storage Criteria	46	Select Cell Constant	96
Set Display Criteria	47	Set Default Temperature	96
View Stored Data	48-49	Set Reference Temperature	96
		Set Temperature Coefficient	96
		Set Alarm Limits	97
		Set Print Criteria	97
		Set Data Storage Criteria	98
		Set Display Criteria	98
		View Stored Data	98
Ion Setup			
Ion Setup Screen and Function Buttons	50		
Access Ion Setup	51		
Set Sample ID#	52		
Ion Method	53		
Select Electrode Type	54		
Select Measurement Units	54		
Select Auto Read Mode	55		
Select Ion Stability Criteria	55		
Set Default Temperature	56		
Set Temperature Compensation	57		
Set Isopotential Point	57		
Set Alarm Limits	57		
Set Print Criteria	58		
Set Data Storage Criteria	59		
Set Display Criteria	60		
View Stored Data	61-62		

XL 60 Meter: Table of Contents

TDS (Total Dissolved Solids) Setup

TDS Setup Screen and Function Buttons	99
Access TDS Setup	100
Set SampleID#	101
Set Calibration Points	101
Select Stable Indicator	101
Select Auto Read Mode	101
Select Cell Constant	102
Set TDS Factor	102
Set Default Temperature.....	102
Set Reference Temperature	102
Set Temperature Coefficient	103
Set Alarm Limits.....	103
Set Print Criteria.....	103
Set Data Storage Criteria.....	104
Set Display Criteria	104
View Stored Data	104

Salinity Setup

Salinity Setup Screen and Function Buttons	105
Access Salinity Setup	106
Set Sample ID#	107
Set Calibration Points	107
Select Stable Indicator	107
Select Auto Read Mode	107
Select Cell Constant	108
Set Default Temperature.....	108
Set Reference Temperature	108
Set Temperature Coefficient	108
Set Alarm Limits.....	109
Set Print Criteria.....	109
Set Data Storage Criteria.....	110
Set Display Criteria	110
View Stored Data	110

pH Operation

About pH Measurement.....	110
Standardizing	
with Auto Buffer Recognition.....	112
Standardizing	
with Manual Buffer Recognition	113
Temperature Standardization	114
pH Measurement with Auto Read	
On And Off.....	115
Graphing Function	116

mV Operation

About mv Measurement.....	117
Absolute mv Measurement	118
Relative mv Standardization and Measurement	118
Graphing Function	119

Ion Operation

About Ion MEASUREMENT.....	120
DIRECT READING METHODS	121-124
Standardization: Direct Reading	
with Standards	121
Measurement: Direct Reading	
with Standards	122
Standardization: Direct Reading	
with Blank Offset	123
Measurement: Direct Reading	
with Blank Offset	124
INCREMENTAL METHODS	125-133
Standardization: All Incremental Methods	125
Measurement: Known Addition Method.....	126-127
Measurement: Known Subtraction Method.....	128-129
Measurement: Analate Addition Method.....	130-131
Measurement: Analate Subtraction Method	132-133
Graphing Function	134

DO Operation

STANDARDIZING	135-141
About DO Standardizing.....	135-136
Automatic at One Point—% Saturation	137
Automatic at Two Points—% Saturation	138
Automatic at One Point—mg/L.....	139
Manual at One Point—% saturation and mg/L	140
Temperature Standardization	141
MEASUREMENT.....	142-152
About DO Measurement.....	142
Auto Read ON and Auto Read OFF	142

About BOD Measurement	143
BOD Calculation Parameters	144
Measurement of BOD of Sample.....	145
Initial DO measurement for Sample	
BOD calculation.....	146
Measurement of BOD of Seed	147
Initial DO measurement for Seed	
BOD Calculation	147
Final DO Measurement for Sample	
BOD Calculation	148
Final DO Measurement for Seed BOD Calculation .	149
Editing Select View Screen	150

OUR Measurement.....	151
----------------------	-----

SOUR Measurement	152
------------------------	-----

DO Graphing Function.....	153
---------------------------	-----

Conductivity Operation

About Conductivity Measurement.....	154
Standardizing	155-156
With Auto Buffer Recognition	155
With Manual Buffer Recognition	156
Temperature Standardization	157
Conductivity Measurement	158
Graphing Function	159

Warranty	160
----------------	-----

Compliance	160
------------------	-----

Appendix

Setting the XL Series Meters User Profiles	161-163
XL Series Meters	
Factory Default Settings	164-166
XL Series Meters	
Print Function	167-168
Background and color adjustment.....	169-170
Determining Isopotential Points	
Experimentally	171
pH Theory.....	172-175
ISE Theory.....	176-179
DO Theory	180
Replatinization.....	181
Conductivity Theory.....	182-184
Replacement Parts	185-187

Introduction

XL15, 20, 25, 30, 40, 50 and 60 meters

Thank you for selecting a Fisher Scientific accumet meter. You have one of these XL series models:

- **XL15** – pH/mV/Temp meter
- **XL20** – pH/mV/Temp/Conductivity meter
- **XL25** – pH/mV/Temp/Ion meter
- **XL30** – Conductivity/ Resistivity/TDS/Salinity/Temp meter
- **XL40** – DO/BOD/OUR/SOUR meter
- **XL50** – pH/mV/Temp/Ion/Conductivity meter
- **XL60** – pH/mV/Temp/DO/Ion/Conductivity meter

This manual describes the operation of the accumet XL series meters. For the model of your purchase, simply use the model's Table of Content to guide you to your meter's operating instructions.

The state-of-the art meter that you have purchased runs on a Windows CE platform and has a similar framework of a pocket PC (or "Palm Pilot").

It is easy to operate and will guide you through the various functions by displaying easy to understand prompts. This operating manual should answer any questions that might arise in operating your meter; however, do not hesitate to call our accumet Technical Support Hotline at 1-888-358-4706, if you need any assistance.

This meter is designed to provide all the information necessary to guide you through the measurement process with a series of prompts on the screen. The XL series meters provide microprocessor precision in a compact bench top design that is easy to use, letting you:

- Measure pH or pH (FET); absolute mV or relative mV (Applicable only for XL15, XL20, XL25, XL50, and XL60)
- Measure ion concentration (Applicable only XL25, XL50, and XL60)
- Measure conductivity, resistivity, Total Dissolved Solids (TDS) and salinity (Applicable only for XL20, XL30, XL50, and XL60)
- Measure DO, BOD, OUR and SOUR (Applicable only for, XL40 and XL60)
- Select one of three sets of standard pH buffer groups (Applicable only for XL15, XL20, XL25, XL50, and XL60)
- Standardize with up to 5 pH standard or custom buffers (Applicable only for XL15, XL20, XL25, XL50, and XL60)
- Standardize with up to 4 conductivity standards (Applicable only for XL20, XL30, XL50, and XL60)
- Implement automatic pH buffer recognition (Applicable only for XL15, XL20, XL25, XL50, and XL60)
- Implement automatic conductivity standard recognition (Applicable only for XL20, XL30, XL50, and XL60)
- Select one of six ion standardization methods (Applicable only for XL25, XL50, and XL60)
- Standardize Dissolved Oxygen with up to two standards (Applicable only for XL40, and XL60)
- Customize your display and operating parameters (Applicable for XL15, XL20, XL25, XL30, XL40, XL50, and XL60)
- Assign operator and sample identification numbers (Applicable for XL15, XL20, XL25, XL30, XL40, XL50, and XL60)
- Specify ion selective electrode type (Applicable only for XL25, XL50, and XL60)
- Store 1000 data points per user in the meter's memory or transfer data to a computer or printer. (Applicable for XL15, XL20, XL25, XL30, XL40, XL50, and XL60)
- Access extensive help with just a touch of a button (Applicable for XL15, XL20, XL25, XL30, XL40, XL50, and XL60)

It all adds up to rapid, completely automatic, intuitive operation.



Introduction

XL15, 20, 25, 30, 40, 50 and 60 meters

Unpacking the Meter

The following is a listing of what you should have received with your new accumet XLseries bench top meter.

Meter with kit includes:	XL15	XL20	XL25	XL30	XL40	XL50	XL60
meter	●	●	●	●	●	●	●
power supply	●	●	●	●	●	●	●
electrode arm support bracket	●	●	●	●		●	●
electrode arm	●	●	●	●		●	●
manual and literature	●	●	●	●	●	●	●
pH electrode (13-620-130)	●	●	●			●	●
Conductivity 13-620-100, 2 cell, 1.0 cell constant				●		●	
ATC probe (13-620-19)	●	●	●			●	●
BOD probe (13-620-SSP; with XL60D kit only)					●		●

Meter only includes:	XL15	XL20	XL25	XL30	XL40	XL50	XL60
meter	●	●	●	●	●	●	●
power supply	●	●	●	●	●	●	●
electrode arm support bracket	●	●	●	●		●	●
electrode arm	●	●	●	●		●	●
manual and literature	●	●	●	●	●	●	●

If any of these items are missing, please contact the accumet Technical Support Hotline at 1-888-358-4706. Accessory Conductivity Probes and Ion Selective Electrodes are available and can be ordered by calling Fisher Customer Service at 800/766-7000.

Accessory pH, ISE, and Conductivity probes are available and can be ordered by calling Fisher Customer Service at 800/766-7000

Useful tips will appear in this box throughout this manual.

XL Series Meters Specifications

XL15, 20, 25, 30, 40, 50 and 60 meters

Display	screen size	640x480 digit LCD
	menu options	4 1/2" x 6"
	help screens	extensive
	configurable display	extensive
	keypad controls	yes
		context specific touchscreen (Applicable for XL15, XL20, XL25, XL30, XL40, XL50, and XL60)
General	inputs/outputs	BNC, ATC, DIN (FET)- (XL15, XL20, XL25, XL50, and XL60) DIN (Conductivity) – (XL20, XL30, XL50, and XL60) DIN (DO) – XL40, and XL60 RS232, USB-B, USB-A, RJ45 – (Applicable for all models)
	electrical requirements	115 V/60 Hz, 230 V/50 Hz
	output from PSU	9VDC, 3.3A center negative
	line voltage tolerance	± 10%
	input impedance	>10 ¹² ohms
	meter size	6.75"x9.25"x3.5"
	meter weight	2.8 lb.
Memory	internal diagnostics	1000 data pts
	programmable data storage	yes
	programmable data output	store on stable, time, manual timed or logged data
	print interval	3 to 86400 sec
	programmable alarm	yes
		(Applicable for XL15, XL20, XL25, XL30, XL40, XL50, and XL60)
pH Mode	range	-2.000 to 20.000
	resolution	0.1/0.01/0.001
	relative accuracy	± 0.1/0.01/0.002 + 1 Lsd
	automatic buffer recognition	yes
	manual buffer recognition	yes
	calibration points	5
	auto lock	yes
	FET	yes (Applicable only for XL15, XL20, XL25, XL50, and XL60)
mV Mode	range	± 2000.0
	resolution	0.1
	accuracy	± 0.2
		(Applicable only for XL15, XL20, XL25, XL50, and XL60)
Ion Mode	range	1x10 ⁻⁶ to 9.99x10 ¹⁰
	resolution	2 / 3 or 4 digits
	relative accuracy	±0.17n%
	calibration points	5
	incremental methods	KA, KS, AA, AS
		(Applicable only for XL25, XL50 and XL60)

continued on next page



XL Series Meters Specifications

XL15, 20, 25, 30, 40, 50 and 60 meters

Conductivity Mode

cell constants range	0.1, 1.0, 10
conductivity	0 to 500 mS/cm over 4 ranges 0 to 200.0 μ S, 200.0 μ S to 2.000 mS, 2.000 to 20.00 mS, 20.00 to 500.0 mS
resistivity	3 ohm-cm to 100 megohm-cm over 4 ranges 0 to 20.00 KOhms, 20.00 to 200.0 KOhms, 200.0 KOhms to 2.000 MOhms, 2.000 to 100.0 Mohms
Total Dissolved Solids (TDS)	0.0 to 500.0 ppt over 4 ranges (depending on the TDS factor) 0 to 200.0 x TDS factor ppm, 200.0 x TDS factor to 2000 x TDS factor ppm, 2.000 x TDS factor to 20.00 x TDS factor ppt, 20.00 x TDS factor to 200.0 x TDS factor ppt
salinity	0 to 90 ppt over 4 ranges 0 to 0.094 ppt, 0.094 to 1.000 ppt, 1.0 to 11.50 ppt, 11.50 to 90.00 ppt
accuracy	0.5% of full scale + 1 digit (Applicable only for XL20, XL30, XL50, and XL60)

Dissolved Oxygen Mode

range	0 to 60 mg/L (0 to 1272 mbar) 0 to 600 % saturation
resolution	0.01 mg/L (0.1 mbar) 0.1 % saturation
accuracy	0.1 + 1 least significant digit (Applicable only for XL40 and XL60)

Temperature Mode

range	-5.0 to +105.0 °C (for meter only) (Applicable only for XL15, XL20, XL25, XL30, XL50, and XL60)
range	-5.0 to +46.0 °C (Applicable only for XL40 and DO mode in XL60)
resolution	0.1 °C
accuracy	\pm 0.2 °C

Barometric Pressure

range	450 to 825 mmHg
resolution	1 mm Hg
accuracy	\pm 1 mm Hg + 1 least significant digit (Applicable only for XL40 and XL60)

Salinity Correction

range	0 to 45 ppt (Applicable only for XL40 and XL60)
-------	--

Operating Conditions

operating temperature	5-45 °C
operation humidity	5-80 % noncondensing
maximum operating altitude	2000m
installation category	II
Pollution category degree	2
	(Applicable for XL15, XL20, XL25, XL30, XL40, XL50, and XL60)



Getting Started: XL Series Meters Connectors XL15 and 20 meters

1. Review the layout and arrangement of the rear connector panel.

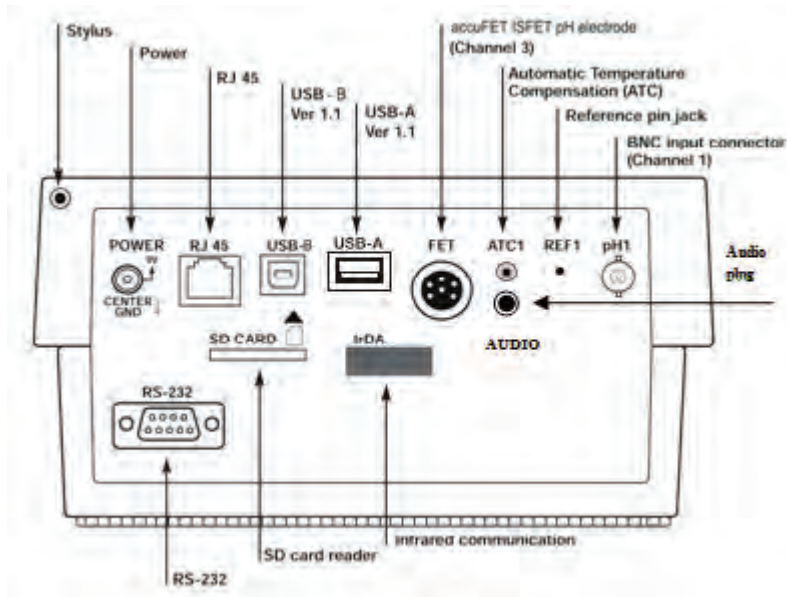

XL15 rear connector panel

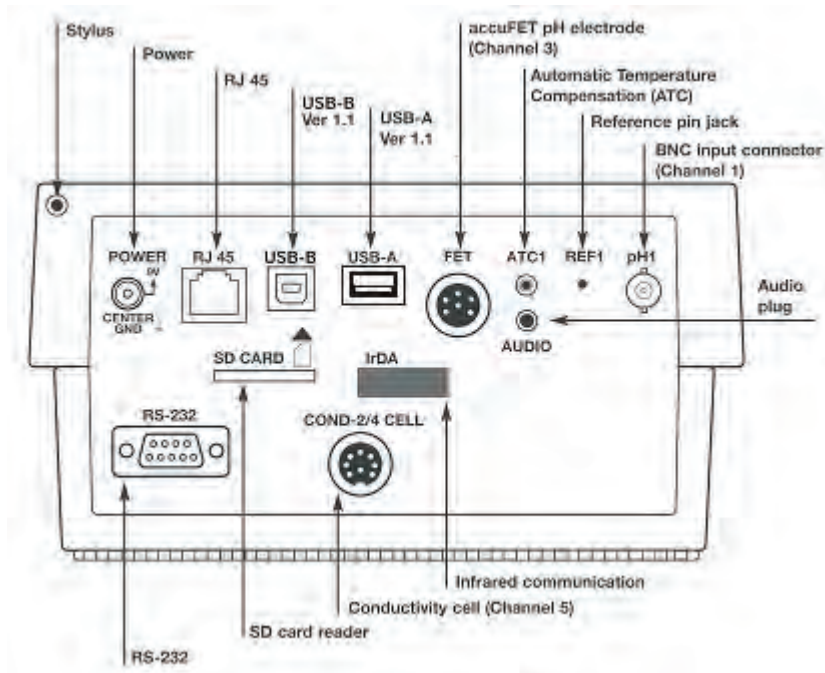

XL20 rear connector panel

Getting Started: XL Series Meters Connectors

XL25 and 30 meters

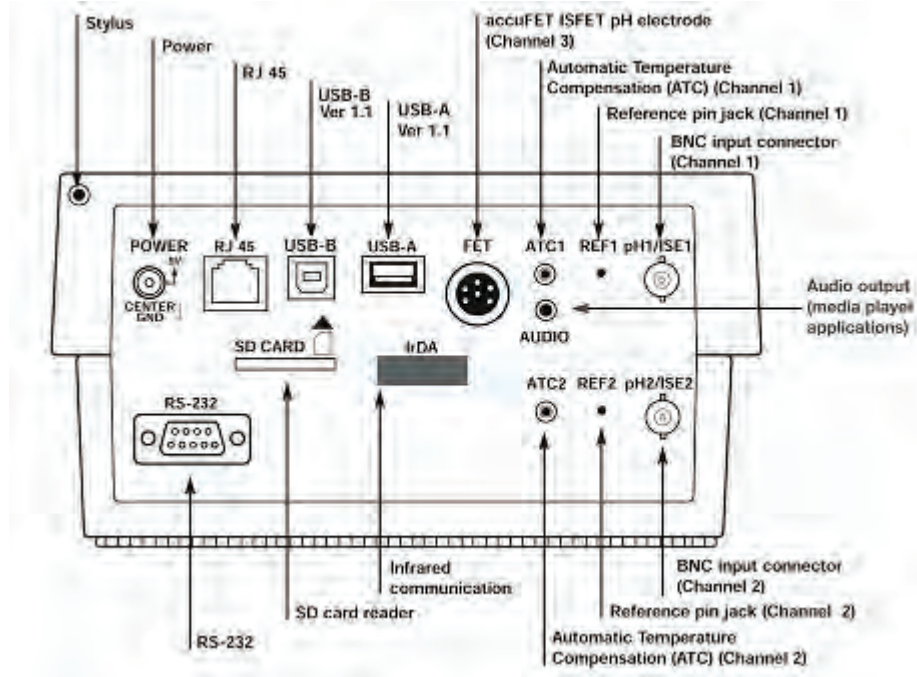

XL25 rear connector panel

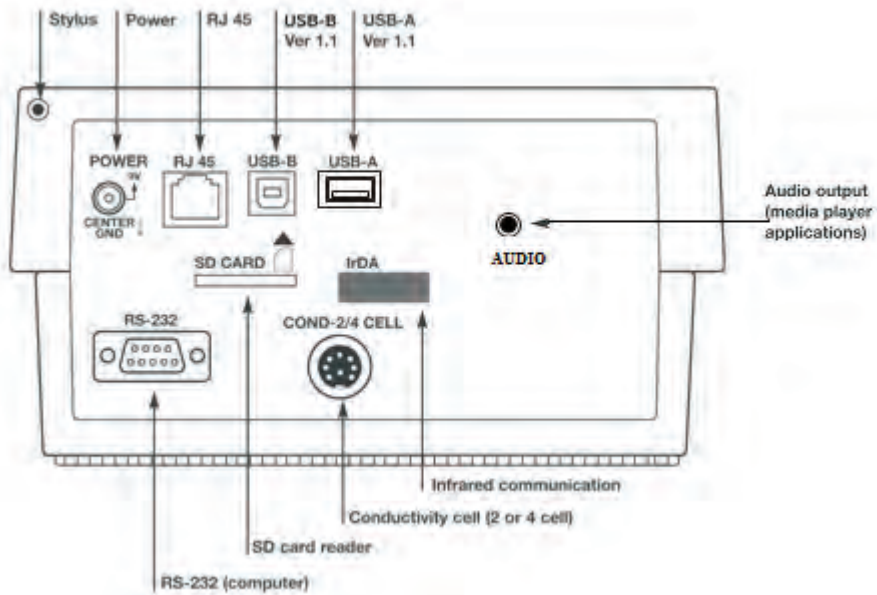

XL30 rear connector panel

Getting Started: XL Series Meters Connectors

XL40 and 50 meters

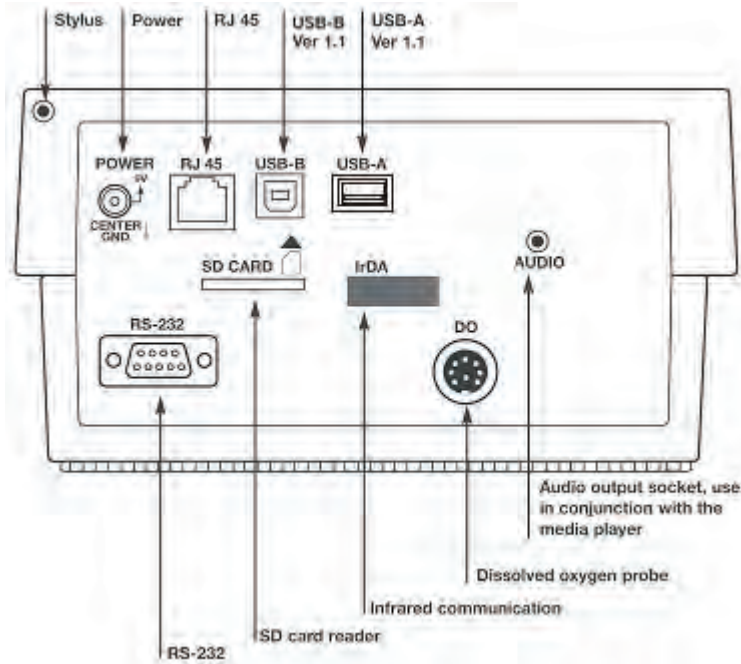

XL40 rear connector panel

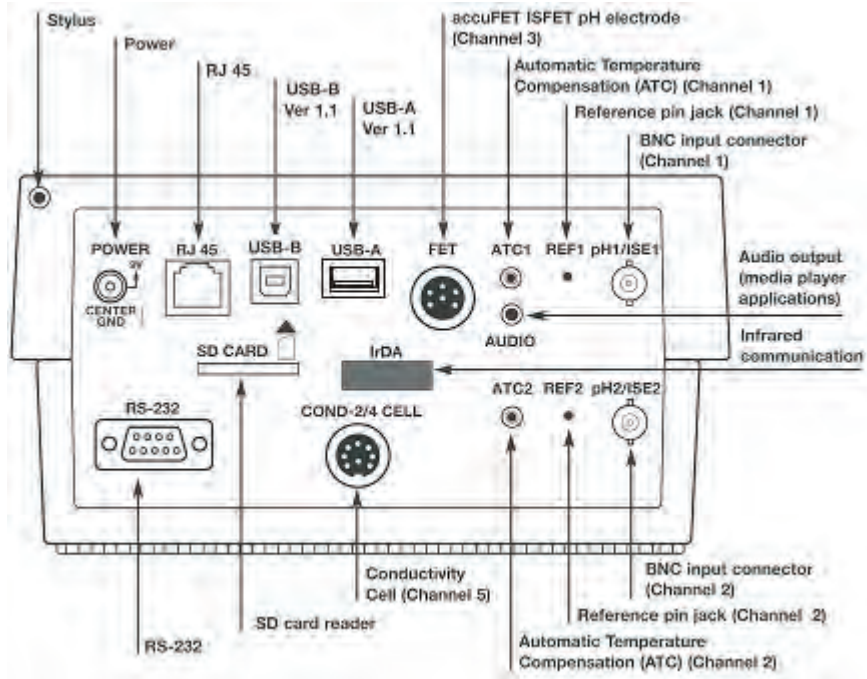

XL50 rear connector panel

Getting Started: XL Series Meters Connectors XL60 meter

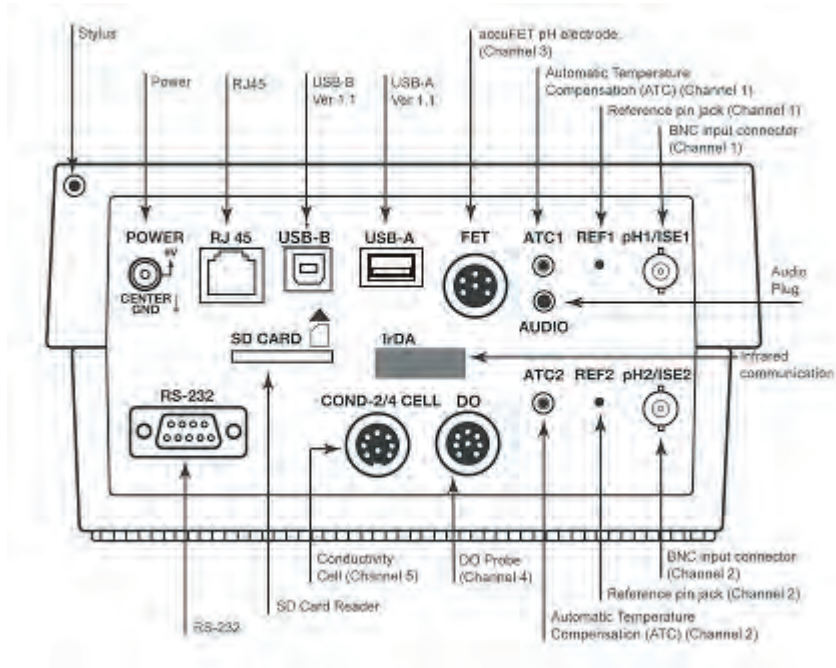

XL60 rear connector panel

2. Connect the electrode arm to the base.
Electrode base can be attached to either side of meter. Purchase additional arm with base (13-637-671) to use both sides.

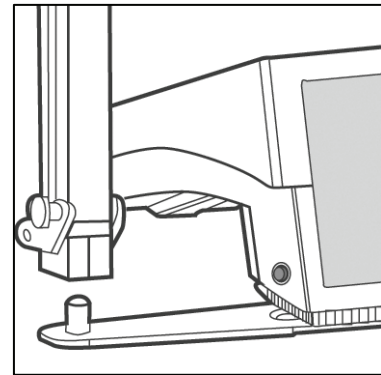

Getting Started: Startup and Shut down procedures XL15, 20, 25, 30, 50 and 60 meters

Important: It is recommended to follow the following start-up and shut down procedures to avoid crashes, lock-ups or data loss. Start and shut down procedures are also illustrated on the slip attached with the adaptor cable.

Start-up procedure:

1. Connect the 9V DC power jack of the adaptor to the rear connector panel of the XL meter.
2. Connect 2 pin power plug into the power outlet or terminal strip.
3. Switch power on (wall socket or terminal strip).
4. Press the black button on the base of the meter for 5 seconds.
5. Release the button to power on the meter.

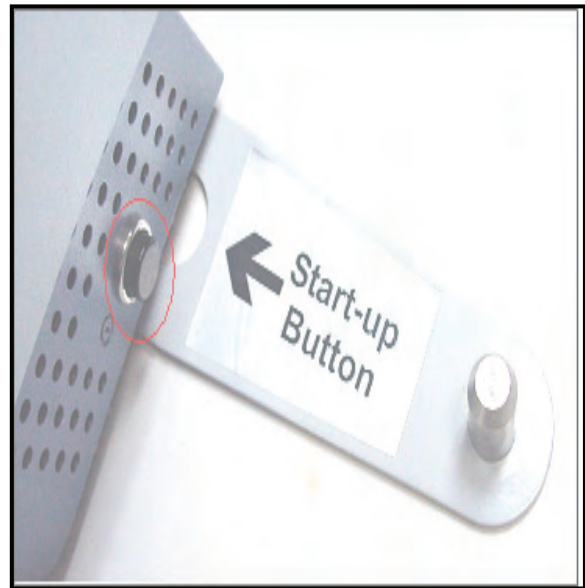

Shut down procedure:

1. Close all applications and log off.
2. From the HOME screen tap the bottom of the screen to bring up the task bar.
3. Tap Start>Shut down. This launches Shut down window.
4. Tap the Yes button on Shut down window to power off the meter.

Caution: Do not remove power from the XL meter until the meter shuts down.

Getting Started: Startup and Shut down procedures XL 40 meter

Important: It is recommended to follow the following start-up and shut down procedures to avoid crashes, lock-ups or data loss. Start and shut down procedures are also illustrated on the slip attached with the adaptor cable.

Start-up procedure:

1. Connect the 9V DC power jack of the adaptor to the rear connector panel of the XL meter.
2. Connect 2 pin power plug into the power outlet or terminal strip.
3. Switch power on (wall socket or terminal strip).
4. Press the black button on the base of the meter for 5 seconds.
5. Release the button to power on the meter.

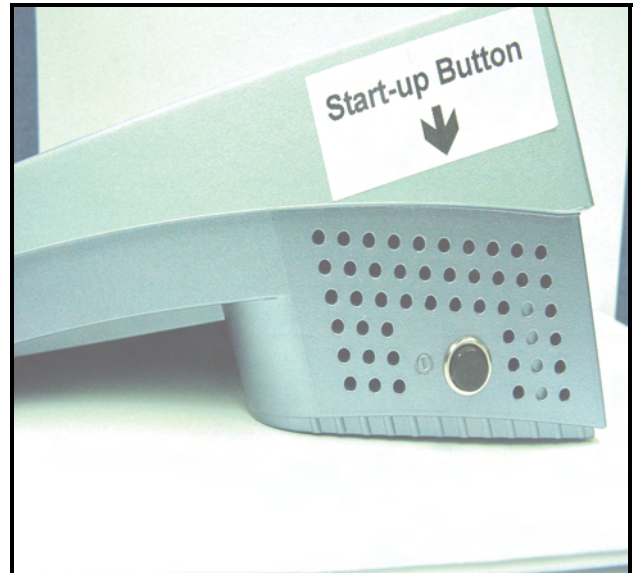

Shut down procedure:

1. Close all applications and log off.
2. From the HOME screen tap the bottom of the screen to bring up the task bar.
3. Tap Start>Shut down. This launches Shut down window.
4. Tap the Yes button on Shut down window to power off the meter.

Caution: Do not remove power from the XL meter until the meter shuts down.

Getting Started: pH and Ion Probes

XL15, 20, 25, 50 and 60 meters

The XL series meters - XL15, XL20, XL25, XL50 and XL60 - allows you to use two types of pH electrodes: the conventional glass pH electrode and the AccuFET field effect transistor (FET) pH electrode.

1. Carefully remove the protective cover from the end of the electrode. Before first using your glass pH electrode, or whenever the electrode is dry, soak it 2-4 hours in an electrode storage solution, pH 4 Buffer, or KCl solution.

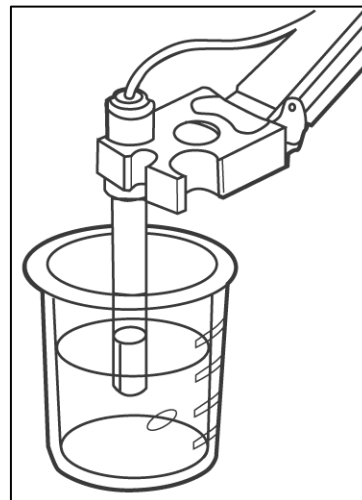

2. Remove the shorting cap on BNC connector. Connect the combination pH electrode by plugging it into the BNC input connector (twisting to lock in place).

If a combination electrode isn't used, connect the indicating pH electrode into the BNC input connector. Plug the reference electrode into the reference pin jack. Also, install the ATC probe into the ATC jack.

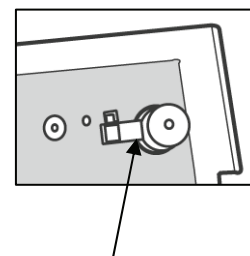

Shorting cap

Note: Be sure to connect all probes to the appropriate channel connectors (for example: pH1, Ref 1 and ATC1).

Option: Connect the optional AccuFET electrode by plugging it into the FET jack on the back meter panel. Allow the AccuFET to warm up five minutes before use.

Connect ion specific electrodes in the same manner as pH electrodes.

Do not discard the BNC shorting cap.

Getting Started: pH and Ion Probes

XL15, 20, 25, 50 and 60 meters

3. Rinse and blot-dry (don't wipe) electrodes between each measurement. Rinse electrodes with distilled or deionized water, or a portion of the next solution to be measured.

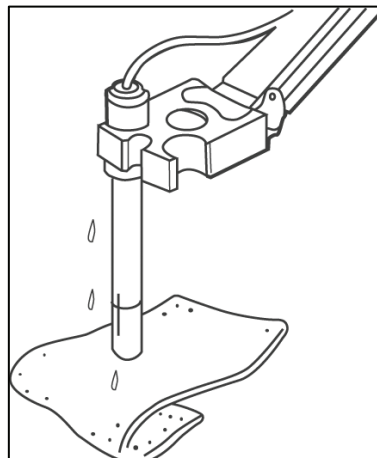

4. Between measurements, store conventional pH electrodes in electrode storage solution, pH 4 buffer, or KCl solution. Always leave the filling hole of liquid filled combination electrodes open. Refill when the level of solution gets below the manufacturer's recommended level.

Store ion specific electrodes according to electrode manufacturer's recommendations.

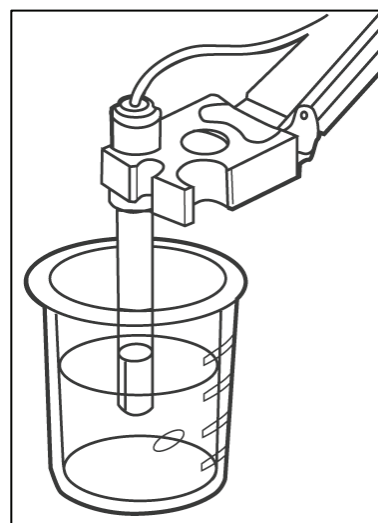

Proper electrode care is fundamental to obtaining reliable pH measurements. Improper care of the electrode may cause the meter reading to drift, respond slowly, or produce erroneous readings. For this reason, the electrode should always be conditioned and used in accordance with manufacturer's instructions.

Getting Started: Conductivity Cells

XL20, 30, 50 and 60 meters

The XL series meter – XL20, XL30, XL50 and XL60 - allows you to use two types of conductivity cells: the 2-cell conductivity cell and the 4-cell conductivity cell with DIN connector. Only one type of conductivity cell can be connected at a time.

1. Carefully remove the protective cover from the end of the conductivity cell. Before using your conductivity cell, soak it for 5 to 10 minutes in distilled or deionized water.

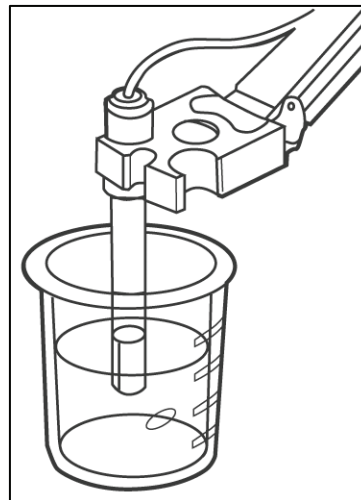

2. Connect the 2-cell or 4-cell conductivity cell to the conductivity cell jack. The 2-cell and 4-cell accumet conductivity cells have built in ATC probes. Therefore, there is no need to connect a separate ATC probe.

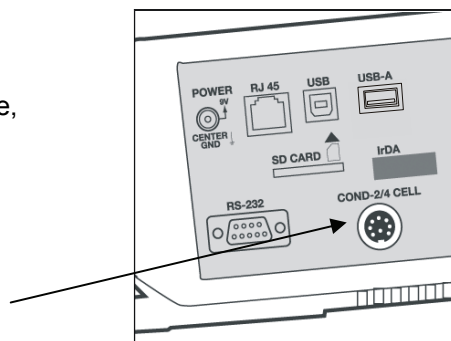

3. Rinse and blot-dry (don't wipe) probe between each measurement. Rinse probe with distilled or deionized water, or a portion of the next solution to be measured.

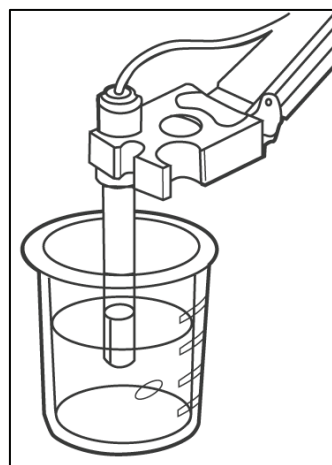
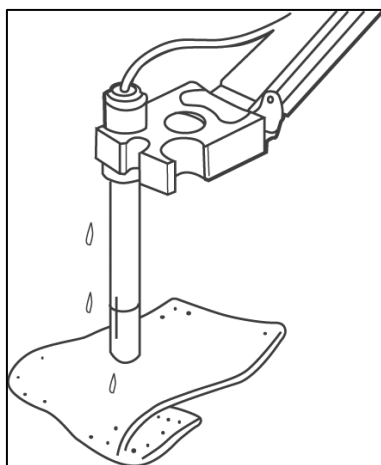

4. Between measurements, conductivity probes can be stored dry.

Getting Started: Dissolved Oxygen Probe XL40 and 60 meters

The XL series meter – XL40 and XL 60 - allows you to use the Fisher Scientific accumet BOD Probe with DIN connector. See '**Replacement Parts**' section for adapters to allow use of YSI Dissolved Oxygen probes with your accumet meter.

1. Carefully review the instruction sheet accompanying the probe for setup and conditioning information.

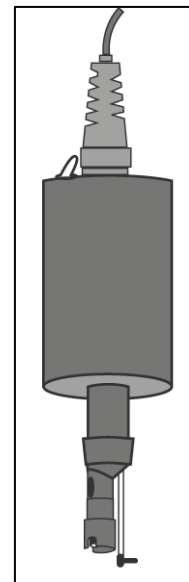
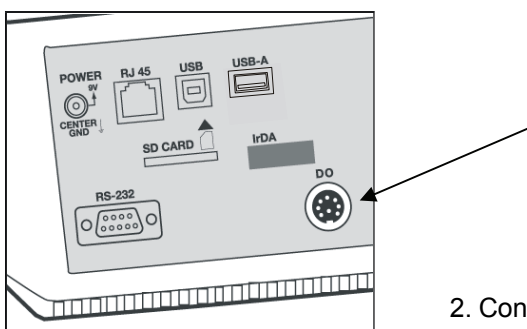

2. Connect the probe to the DO DIN jack on the back of the meter. Allow the probe to warm up for 30 minutes.

3. Store the DO probe in a BOD bottle filled with 1 inch of water.

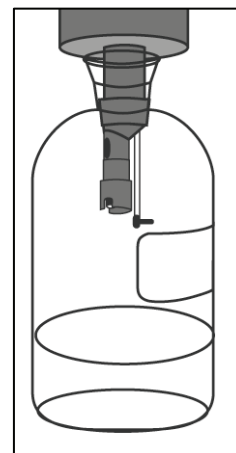

Using the XL Series Meter: Touch Screen Operation

XL15, 20, 25, 30, 40, 50 and 60 meters

When the meter is turned on it first goes through self test, displays the FISHER Catalog cover, briefly displays the desktop screen (Home) before loading the XL series program which results in the display of the measurement screen.

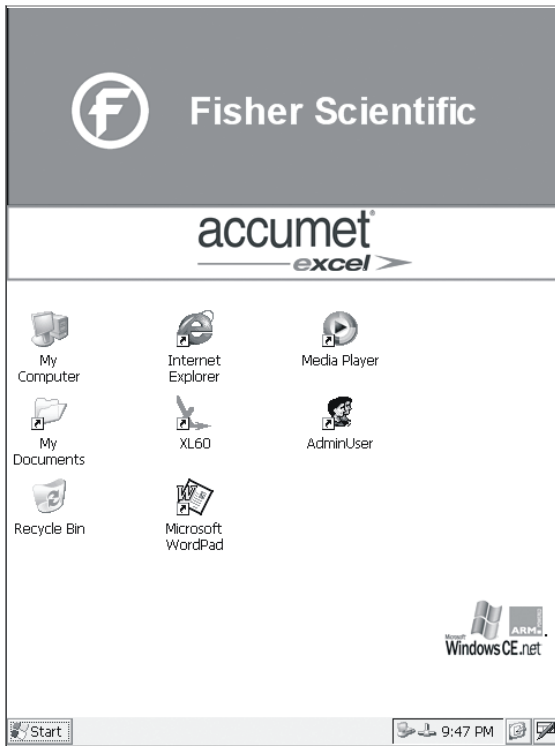

Example:- XL 60 Desktop screen (Home)

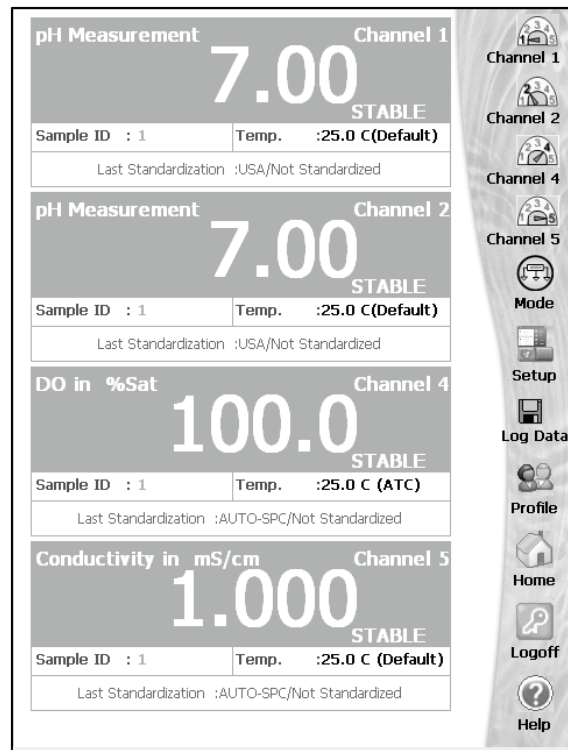

Example of XL series measurement screen: - XL60 meter - pH, pH, DO, and conductivity quadruple measurement screen

Using the XL Series Meter: Touch Screen Operation

XL15, 20, 25, 30, 40, 50 and 60 meters

The new accumet XL series benchtop meter operates with a state-of-the-art touch screen. The touch screen makes this the easiest meter on the market to operate and care for. When the meter is first plugged in, the meter runs a self-test and takes you to the measurement screen. Touch any icon to access the functions of the meter. Your XL series meter also includes a stylus that you can use to tap on your screen. The stylus easily stores inside the back panel of the meter.

The buttons on the right side of the screen control all of the functions of the meter. A light touch on the screen is all that you need to access the various functions. Once you touch a button you will get an audible tone; the screen will not change until you lift your stylus. This design prevents rapid uncontrolled scrolling through the various function screens.

Function buttons and options change from screen to screen. Easy to understand prompts guide you through the operation of the meter in the selected mode. If you are ever in doubt about what to do, just touch Help on the bottom right corner of the screen for detailed information about that screen.

Your meter was shipped with a clear protective sheet to protect the LCD display and “bubbles” may appear on the screen. The screen will respond better and visibility will improve if it is removed. Alternatively, you may choose to leave this on for added protection.

Screen contrast adjustment

You can adjust the contrast of your screen to your requirements.

1. From the HOME screen, tap the bottom edge of the screen to access the Task bar. Tap **Start > Settings > Control Panel**. This launches the Control Panel screen.
2. Double tap the **Display Contrast** icon.
3. Tap the up and down arrows to select your desired contrast level.
4. Tap the **Close** key to exit control adjustment.

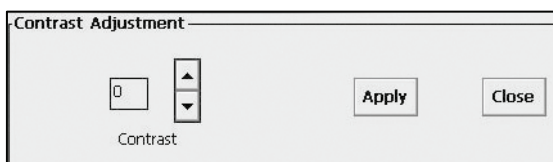

Using the XL Series Meter: Using the Stylus

XL15, 20, 25, 30, 40, 50 and 60 meters

Your XL series meter comes with a stylus that you should use to tap on your screen. The stylus easily stores inside the back panel of the meter.

You can perform two basic actions using the stylus:

Tap

Lightly touch the screen to select or open an item. Lift the stylus after you tap an item. Tapping is equivalent to clicking an item with the mouse on your personal computer. Note: Some program items require a double tap to select or launch. Double tap on the icons from the Desktop (Home) page and single click in the XL series icon application.

Drag

Place the point of the stylus on the screen and drag an item across the screen without lifting the stylus until you have completed the selection. Dragging is equivalent to dragging with the left mouse button pressed on your personal computer.

Stylus Calibration

If the meter is not responding properly to your taps, you may need to recalibrate your screen.

1. From the HOME screen, tap the bottom edge of the screen to access the Task bar. Tap **Start > Settings > Control Panel**. This launches the Control Panel screen.
2. Double tap the **Stylus** icon.
3. Tap the **Calibration** tab to access the calibration screen.
4. Tap the **Recalibrate** button.
5. Carefully tap and briefly hold the stylus on the center of the target. Repeat tapping the target as it moves to the 4 corners of the screen. If you miss the target center, keep the stylus on the screen, slide it over the target's center, and then lift the stylus.
6. Once the calibration is complete, the target will disappear. Tap anywhere in the screen to accept the new calibration and go back to the "Stylus Properties" window. Tap **OK** to close the "Stylus Properties" window.

CAUTION: To prevent damage to your XL series meter screen, never use any device other than the stylus that comes with the meter or an approved replacement to tap on the screen. Order extra or replacements if you lose or break your stylus.

Using the XL Series Meter: Setting Time and Date

XL15, 20, 25, 30, 40, 50 and 60 meters

Setting the Time

1. From the **HOME** screen tap the bottom left of the screen to access the Start menu. Tap **Start > Settings > Control Panel**. This launches the **Control Panel** screen.
2. Double tap **Date/Time** icon. This launches the **Date/Time Properties** window.
3. Tap the time-zone down arrow, and select the appropriate time zone.
4. Tap the hour, minutes, or seconds. Tap up and down arrows to adjust.
5. Tap AM or PM. Use up and down arrow to select.
6. Tap **Apply** button.
7. Tap **OK** to save the time.

Setting the Date

1. From the **HOME** screen tap the bottom left of the screen to access the Start menu. Tap **Start > Settings > Control Panel**. This launches the **Control Panel** screen.
2. Double tap **Date/Time** icon. This launches the **Date/Time Properties** window.
3. Tap the left or right arrow to select a month and year.
4. Tap a day.
5. Tap **Apply** button.
6. Tap **OK** to save the time.

You need to reset your time zone, time, and date if:

- The time changes or you are traveling to a different time zone.

The screenshot shows a 'Date/Time Properties' dialog box. On the left is a calendar for March 2004. On the right, the 'Current Time' is 4:05:27 PM. The 'Time Zone' is set to '(GMT-06:00) Central Time (US & Canada)'. There is an unchecked checkbox for 'Automatically adjust clock for daylight saving'. An 'Apply' button is located at the bottom right of the dialog.

The time on the meter can be synchronized with your personal computer through Microsoft® "Active sync".

Using the XL Series Meter: On-Screen Keyboard

XL15, 20, 25, 30, 40, 50 and 60 meters

Using the On-Screen Keyboard

Use the stylus to tap letters, numbers, and symbols on the on-screen keyboard to enter typed text directly onto the screen.

1. From any application, screen tap the bottom right of the screen to access the input panel. Tap the **Pencil/Keyboard** icon (see below). A pop-up menu will appear.
2. Tap **LargeKB** to display a large keyboard with all function keys. Tap **keyboard** for a basic function alphanumeric keyboard.
3. Tap desired letters, numbers and symbols on the keyboard. Hit the **Enter** key.
4. To remove the keyboard, tap on the **Pencil** icon. The pop-up menu will appear. Tap **Hide Input Panel** to remove keyboard.



To see symbols, tap the **Shift** key.

Using the XL Series Meter : Expansion Cards

XL15, 20, 25, 30, 40, 50 and 60 meters

Secure Digital (SD) Expansion Cards

You can expand the memory and connectivity of your XL series meter.

Use optional expansion cards for:

- Expanding the memory of your XL series meter
- Viewing the content of memory cards

Expansion cards must be purchased separately and are not included with your XL60 meter.

Installing an Secure Digital (SD) Expansion Card

To install a Secure Digital (SD) card into an expansion slot on the XL series meter:

1. Locate the SD card slot on the back of XL series meter.
2. Remove the protective plastic card.
3. Insert the SD card into the SD slot and push firmly

If your expansion card is not recognized, follow the card manufacturer's instructions to install it.

Removing a Secure Digital (SD) Expansion Card

1. Close all applications that are using the SD card.
2. Remove SD card from the SD slot by slightly pushing down on the card to unlock it.
3. When the card disengages and pops up, pull it from the expansion slot.

CAUTION: SD cards must first be unlocked before removal.

Viewing the Content of Secure Digital (SD) Expansion Cards

Use Windows Explorer to view the files that are located on your optional Secure Digital card.

1. From the Start menu, tap Programs >Windows Explorer.
2. Tap the root directory of My Device, and select the Storage Card folder (SDIO) to see a list of files and folders.

Using the XL Series Meter: Connecting to the Internet

XL15, 20, 25, 30, 40, 50 and 60 meters

Connecting the Internet

The XL series meter allows you to connect internet through the RJ-45 port located at the back panel of the XL series.

1. Connect Internet cable to RJ-45 port on the back of the XL Series meter.
2. Power on the XL Series meter.
3. To access and view websites on XL series meter follow the steps mentioned below.

Entering an Internet Address

With Pocket Internet Explorer and a connection to the Internet, you can view Web sites on your XL series meter by typing an address or Universal Resource Locator (URL) in the Address bar. Web sites that use HTML 4.0, DHTML, animated GIF images, and Java applets may not work correctly in Pocket Internet Explorer without additional software.

To enter an Internet address (URL) on your XL series meter:

1. From the Start menu, tap **Programs > Internet Explorer > Address Bar**. If the Address Bar is not visible, tap the **View tab > Address Bar** to turn it on. You may also double tap the Internet Explorer icon on the Home screen to launch Internet Explorer.
2. Enter the Internet address (URL) in the Address bar using the on-screen keyboard.
3. Tap the **Go** icon.

Caution: The internet cable should be connected to the RJ-45 port before the XL meter is switched on to avail the internet connection. If user tries to connect cable after the meter is switched on, the screen will display 'The page cannot be displayed'.

Using a Favorites List

With Pocket Internet Explorer and a connection to the Internet, you can view Web sites on your XL series meter by selecting one from your Favorites list.

To select a Web site from your Favorites list:

1. From the Start menu, tap **Internet Explorer**.
2. Tap the **Favorites** icon and the Web site you want to view.

Using the XL Series Meter: Button Functions

XL15, 20, 25, 30, 40, 50 and 60 meters

The touch screen of your XL series bench meter has “buttons” along the right side of the screen that are common to many of the screens. The following indicates the function of these common buttons.



Channel 1



Channel 2



Channel 3



Channel 4



Channel 5

The **Channel 1, Channel 2, Channel 3, Channel 4 and Channel 5 buttons** access the single display screen corresponding to each channel. If you wish to perform standardization or printing from any of the channels, you need to use single channel mode. The Graph can only be viewed in the single channel mode.

Channel 1	pH, mV or *(ion) channel	Available in XL15, XL20, XL25, XL50 and XL60
Channel 2	pH, mV or *(ion) channel	Available in XL25, XL50 and XL60
Channel 3	pH (FET) channel	Available in XL15, XL20, XL25, XL50 and XL60
Channel 4	DO, BOD, OUR, SOUR channel	Available in XL40 and XL60
Channel 5	Conductivity, Resistivity, TDS or Salinity channel	Available in XL20, XL30, XL 50 and XL60

NOTE: *(ion) channel is for XL25, XL50 and XL60 meters only.



Mode

The **Mode button** allows you to switch between the various operations of the meter—pH, mV, ion, pH (FET), DO, conductivity, resistivity, TDS and salinity. It also lets you configure the display options, select input parameters, and view the software revision and serial number details.



Setup

The **Setup button** will access the setup screens of the channels that you are currently using.



Log Data

The **Log Data button** sends data to the data storage center of the meter if sample ID # has been assigned to your sample.



Profile

The **Profile button** lets you view your profile (User ID, Password, Company Name, User Group). You can change only your profile and not of any other user. You can change to a different user only if you are the default user of the system.



Home

The **Home button** accesses the Windows CE desktop. The XL series application does not shut down if Home is pressed and the current user remains logged in. Double tap on the XL series icon to return to the previous screen before the Home button was pressed.



Logoff

The **Logoff button** allows you to logoff the current user from the XL series application. The XL series application shuts down returning to the Win CE desktop. When you restart the application, you go to the main screen of the application. The second time you are logged in as the default user of the system.



Help

The **Help button** allows you to access helpful information on any screen. Touching the Help button gives you information about the current screen. This information will include step-by-step instructions for operating the meter from the current screen and possible applications information for that screen.



Using the XL Series Meter: Button Functions

XL15, 20, 25, 30, 40, 50 and 60 meters

The following buttons appear in the XL series meters Mode screen:



Replat.

***Replatinization** is the process of replacing the platinum on the surfaces of the 2 cell conductivity probes that may flake or wear off over time. The platinum on the surface of the probe is used to increase the surface area of the measuring surface resulting in decreased polarization error. Replatinization is a relatively quick procedure to perform, taking no more than 5 minutes. See '**Appendix: Replatinization**' for procedure.

*Note: Replatinization function is available in XL20, XL30, XL50 and XL60 meters only.



About

The **About button** lets you view the software revision and serial number details.



Sys. Setup

The **Sys.Setup button** allows you to turn on or off the beep status. This is the audible beep that sounds each time any button is touched.



Multi Channel

The ***Multi Channel button** lets you view multiple channels at the same time.

*Note: This is available in XL20, XL25, XL50 and XL60 meters only.

Single Channel Display

- XL15 (Display - Ch1/Ch3)
- XL30 (Display – Ch5)
- XL40 (Display – Ch4)

Dual Channel Display

- XL20 (Display 1 & 2 - Ch1/Ch3/Ch5)
- XL25 (Display 1 & 2 - Ch1/Ch2/Ch3)

Triple Channel Display

- XL50 (Display 1, 2 & 3 – Ch1/Ch2/Ch3/Ch5)

Quadruple Channel Display

- XL60 (Display 1 , 2 , 3 & 4 – Ch1/Ch2/Ch3/Ch4/Ch5)
-



Display Setup

The ***Display Setup button** lets you configure the display to read the inputs from the channels of your choice.

*Note: Display Setup function is available in XL20, XL25, XL50 and XL60 meters only.



Using the XL Series Meter: Button Functions

XL15, 20, 25, 30, 40, 50 and 60 meters

The following buttons appear in the related XL series meters Mode screen after Channel 1, 2, 3, 4 or 5 is selected:



pH

The **pH mode button** allows you to switch to the various pH operations of the meter (available in Ch 1 and 2 of the XL15, XL20, XL25, XL50, and XL60 meters only).



mV

The **mV mode button** allows you to switch to the various mV operations of the meter (available in Ch 1 and 2 of the XL15, XL20, XL25, XL50, and XL60 meters only).



Ion

The **Ion mode button** allows you to switch to the various ion concentration operations of the meter (available in Ch 1 and 2 of the XL25, XL50, and XL60 meters only).



pH (FET)

The **pH (FET) mode button** allows you to switch to the various pH (FET) operations of the meter (available in Ch 3 of the XL15, XL20, XL25, XL50, and XL60 meters only).



DO

The **DO mode button** allows you to switch to the various dissolved oxygen operations of the meter (available in Channel 4 of the XL 40 and XL60 meters only).



BOD

The **BOD button** allows you to enter the BOD Parameter Calculations Screen in the BOD measurement screen (available in Channel 4 of the XL 40 and XL60 meters only).



OUR

The **OUR button** allows you to Start and Stop the OUR measurement in the OUR measurement screen (available in Channel 4 of the XL 40 and XL60 meters only).



SOUR

The **SOUR button** allows you to Start and Stop the SOUR measurement in the SOUR measurement screen (available in Channel 4 of the XL 40 and XL60 meters only).



Conductivity

The **Conductivity mode button** allows you to switch to the various conductivity operations of the meter (available in Channel 5 of the XL 20, XL30, XL50 and XL60 meters only).



Resistivity

The **Resistivity mode button** allows you to switch to the various resistivity operations of the meter (available in Channel 5 of the XL 20, XL30, XL50 and XL60 meters only).



TDS

The **TDS mode button** allows you to switch to the various TDS operations of the meter (available in Channel 5 of the XL 20, XL30, XL50 and XL60 meters only).



Salinity

The **Salinity mode button** allows you to switch to the various salinity operations of the meter (available in Channel 5 of the XL 20, XL30, XL50 and XL60 meters only).



Using the XL Series Meter: Button Functions

XL15, 20, 25, 30, 40, 50 and 60 meters

The following button appears in all XL series meters single channel screens:



The **Print button** will send information to the output device that is connected to your meter. If you selected the "Log data" option in the "Print criteria" setup, clicking on the print button will dump the logged data to the printer.



The **Standardize button** accesses the standardization screen from the various measure modes and initiates standardization of the meter once the standardization screen is accessed. Not available from mV screen.



The **Measure button** directs the meter to measure your sample when in the Auto Read function. Not available from mV, BOD, OUR, and SOUR screens.

The following buttons appear in the XL15, XL20, XL25, XL50 and XL60 meters mV single channel screen:



The **rel mV button** returns the meter into the relative millivolt mode when in the absolute mV mode. When this mode is activated, a window will appear asking you to set a relative mV value or accept the default value of 0 mV. This feature may assist the user to standardize certain analytical and monitoring activities such as titration.



The **abs mV button** returns the meter to absolute millivolt mode when the meter is in relative mV mode. It only appears when the meter is in the relative mV mode.

The following buttons appear in the XL40 and XL 60 meters *Dissolved Oxygen channel screen:



The **BOD button** allows you to enter the BOD Parameter Calculations Screen from the BOD measurement screen.



The **OUR button** allows you to Start and Stop the OUR measurement from the OUR measurement screen.



The **SOUR button** allows you to Start and Stop the SOUR measurement from the SOUR measurement screen.

The following buttons appear in all XL series meters standardization screens:



The **Confirm button** accepts current value of the buffer or standard solution.



The **Clear button** clears all previous standardization points.



The **Cancel button** cancels current standardization and returns to the measurement screen.



The **Temp Std button** allows you to check the accuracy of your temperature probe and standardize to an accurate thermometer.



Using the XL Series Meter: Channel Assignment

XL15, 20, 25, 30, 40, 50 and 60 meters

The XL series meters features up to five channels depending on the models you have purchased.

- **XL15** – Channel 1/3 (pH,mV / pH FET)
- **XL20** – Channel 1/3/5 (pH,mV, / pH FET / Conductivity,Resistivity,TDS,Salinity)
- **XL25** – Channel 1/2/3 (pH,mV,ion / pH FET)
- **XL30** – Channel 5 (Conductivity,Resistivity,TDS,Salinity)
- **XL40** – Channel 4 (DO,BOD,OUR,SOUR)
- **XL50** – Channel 1/2/3/5 (pH,mV,ion / pH FET / Conductivity,Resistivity,TDS,Salinity)
- **XL 60** – Channel 1/2/3/4/5 (pH,mV,ion / pH FET / DO,BOD,OUR,SOUR /Conductivity,Resistivity,TDS,Salinity)

Assigning the channels

1. Touch the Mode button on the Measure screen.
2. Choose the desired channels for your application.
 - **XL15** - Touch the input channel (Ch1 and/or Ch3) on the back panel image to select the parameter assigned to that channel. Touch the appropriate parameter icon to assign an input to each desired channel.
 - **XL30 and XL40** - Touch the appropriate parameter icon to assign an input to each desired channel.
 - **XL20, XL25, XL50 and XL60** - Touch **Channel** button (Ch1, Ch2, Ch3, Ch4 and/or Ch5) to select the parameter assigned to that channel. Touch the appropriate parameter icon to assign an input to each desired channel.
3. To deselect a channel, simply touch the **Channel** button again (or input channel on back panel).
4. If multiple channels are assigned, touch the **Display Setup** button to select and assign displayed windows (refer to next page for directions).
5. To return to measurement mode, touch **Multi Channel** (if two or more channels are assigned) or touch Single Channel (if one channel is assigned).

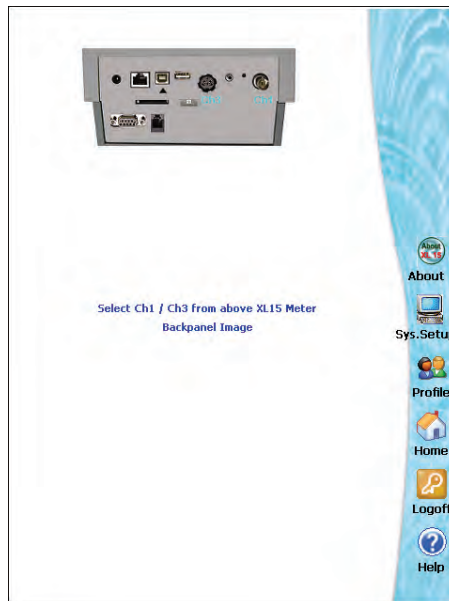

Assigning channel for XL15 meter

Using the XL Series Meter: Channel Assignment

XL15, 20, 25, 30, 40, 50 and 60 meters



Assigning channel for XL30

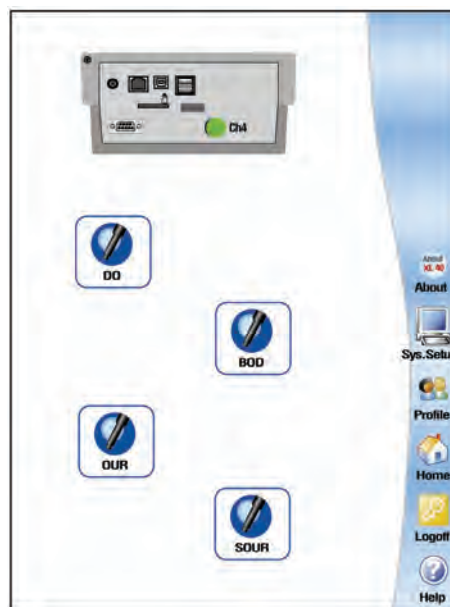

Assigning channel for XL40

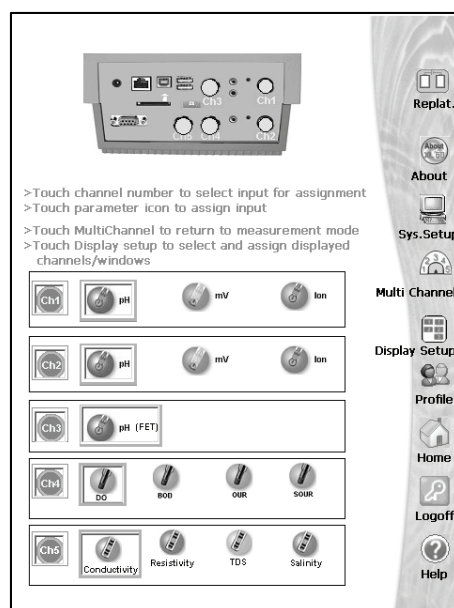

Assigning channels for XL20, XL25, XL50 and XL60 (example shown is XL60)

Based on the assigned channels, selected meter models can feature up to a quadruple (XL60), triple (XL50), dual (XL20 and XL25), or single (XL15, XL30 and XL40) display mode where all selected screens are shown simultaneously. The parameters being displayed is based on the Display Setup (see **'Using the XL Series Meter: Display Setup'** section for directions). This is only available in XL20, XL25, XL50 and XL60 meters since XL15, XL30 and XL40 meters features only single display mode.

Using the XL Series Meter: Display Setup

XL15, 20, 25, 30, 40, 50 and 60 meters

Your XL series meters have the following display configuration:

- **XL15** – 1 Display (Selectable from Ch1/Ch3)
- **XL20** – Up to 2 Displays (Selectable from Ch1/Ch3/Ch5)
- **XL25** – Up to 2 Displays (Selectable from Ch1/Ch2/Ch3)
- **XL30** – 1 Display (Selection from Ch5)
- **XL40** – 1 Display (Selection from Ch4)
- **XL50** – Up to 3 Displays (Selectable from Ch1/Ch2/Ch3/Ch5)
- **XL 60** – Up to 4 Displays (Selectable from Ch1/Ch2/Ch3/Ch4/Ch5)

According to the above configuration, the Display Setup mode lets you select which channel will appear in each display. Access the Display Setup button from the Mode screen when multiple channels are selected.

To configure the display:

1. Touch the desired **Display** box.
2. Touch any one of the **Channel** boxes to the right of the display box to assign the channel to the selected display.
3. To reassign any of the displays, touch the Display box again and the allocation clears.

Touch the **M. Channel** button to save the configuration and return to the Measurement screen.

Touch the **OK** button to save the display configuration and return to the Mode screen.

Touch the **Cancel** button to exit and return to the Mode screen without saving changes.

When you touch the **Help** button, information about the current screen appears. This information includes step-by-step instructions for operating the meter from the current screen and possible applications information for that screen.

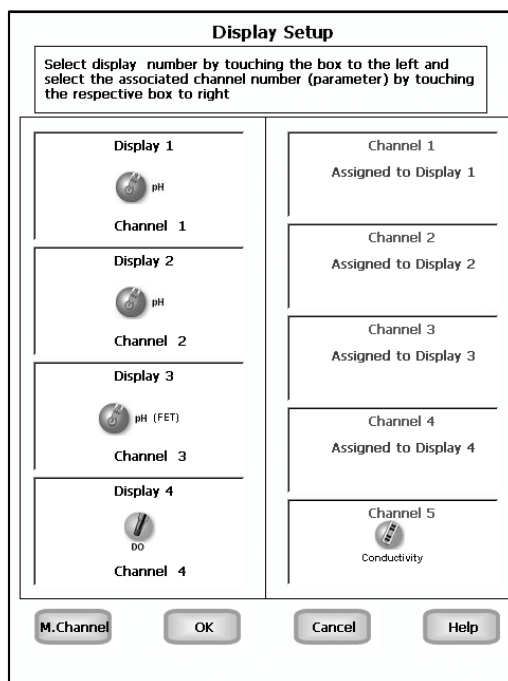

Example: - XL60 Display Setup screen

pH Setup: pH Setup Screen

XL15, 20, 25, 50 and 60 meters

Available only in XL15, XL20, XL25, XL 50 and XL60 meters, the pH Setup screen presents many options to control the pH operating parameters of the meter. The meter is factory set with regard to these options, and is ready for use under most circumstances (see '**Appendix: XL Series Meters Factory Default Settings**' section for default settings). The pH Setup section will guide you through the various options available in the pH setup mode.

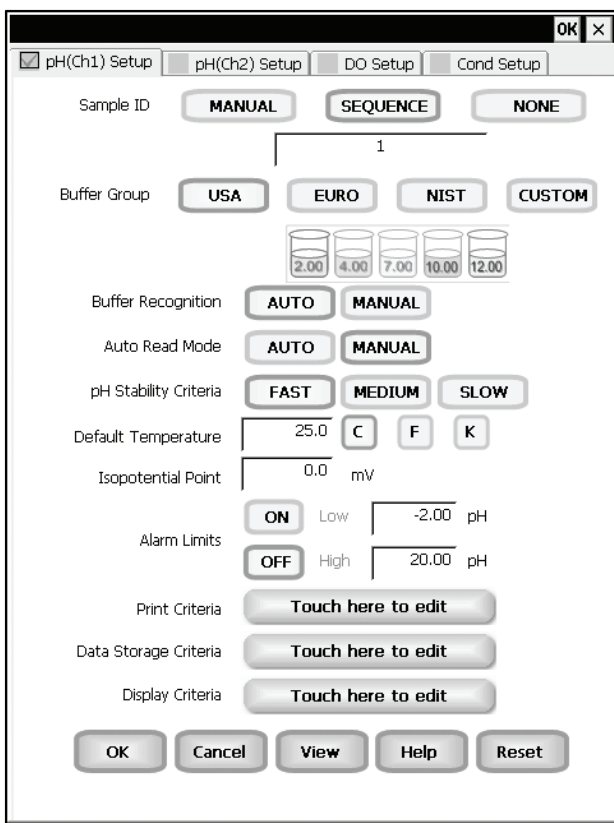

Example: - XL60 pH Setup screen

Function Buttons on pH Setup Screen

Touch **OK** to confirm pH Setup and return to the pH Measure screen.

Touch **Cancel** to exit and return to the pH Measure screen without confirming pH Setup.

Touch **View** to view all pH data points stored in memory. See '**pH Setup: View Stored Data**' section for details.

When you touch the **Help** button, information about the current screen appears. This information includes step-by-step instructions for operating the meter from the current screen and possible applications information for that screen.

Touch **Reset** to reset all pH Setup Criteria to the factory default.

pH Setup: Access pH Setup

XL15, 20, 25, 50 and 60 meters

To access the Setup screen:

1. Make sure you are in the pH Measure screen.
2. Touch the **Setup** button to access the pH Setup screen.

If you were in quadruple, triple or dual display mode, you have access to the Setup mode for each channel displayed. Touch the **Setup Channel** buttons at the top of the screen to toggle back and forth between the setup screens for each channel. To change pH parameters, select the pH Setup button.



If you were in single display mode, you will access the Setup mode for the single channel displayed only.

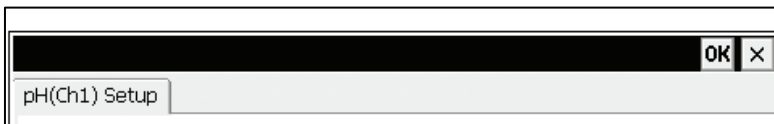

pH Setup: Set Sample ID#

XL15, 20, 25, 50 and 60 meters

A sample ID is required if you wish to log data or activate a timed printing. Whenever this option is active, each time you touch Log Data (available on the single display pH Measure screen), the pH (or pH FET) value along with date/time/channel and the sample ID will be sent to data storage.

You can manually enter an alphanumeric identification number of 10 characters for any sample or you can have the meter sequentially number your samples beginning at the number of your choice. You can also choose to deactivate the sample ID.

To set sample ID — Manual:

1. Touch **Manual** for manual Sample ID entry
2. The current ID is displayed on the screen
3. Use the alphanumeric keypad on the screen to enter the desired Sample ID. The **BS** key will allow you to backspace to remove a character that was incorrectly entered.
4. Touch **Enter** to accept current Sample ID and return to the pH (or pH FET) Setup screen.

To set sample ID — Sequential

1. Touch **Sequence** for sequential Sample ID entry
2. The current ID is displayed on the screen
3. Use the numeric keypad on the screen to enter the desired Sample ID number that you would like your sequential Sample ID assignment to begin with. Every time you touch **Print** or **Log Data** on the pH Measure screen, the Sample ID will increase by 1. The **BS** key will allow you to backspace to remove a character that was incorrectly entered.
4. Touch **Enter** to accept the first sequential Sample ID and return to the pH (pH FET) Setup screen.

To deactivate the sample ID assignment — None

1. Touch None to deactivate the sample ID assignment

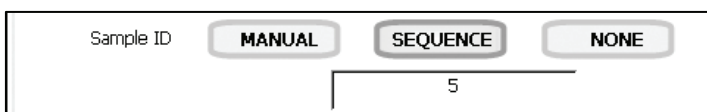

pH Setup: Select Buffer Group

XL15, 20, 25, 50 and 60 meters

This setup option allows you to select from 3 different buffer groups, for auto buffer recognition. Or you can create a custom group of buffers for auto buffer recognition by touching custom.

The 3 existing buffer groups are:

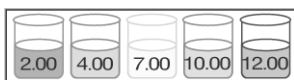

USA buffers: 2.00, 4.00, 7.00, 10.00, 12.00

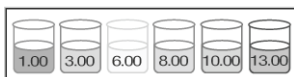

European buffers: 1.00, 3.00, 6.00, 8.00, 10.00, 13.00



NIST buffers: 1.68, 4.01, 6.86, 9.18, 12.45

To select a buffer group

1. Touch USA, EURO, NIST or CUSTOM from the setup screen to select a buffer group.

To set a Custom pH buffer group

This option allows you to create a custom buffer group of up to 5 buffers (2 buffer minimum) to be used for auto buffer recognition. To obtain optimal results, it is important to maintain at least 1 pH unit between selected buffers in the custom group.

1. Touch CUSTOM on the setup screen to select a custom buffer. This will display a set of 5 custom beakers each initialized to zero.



2. Touch one of the beakers to display the numeric keypad.
3. Enter a value for the custom pH buffer that you want set in your custom buffer set.
4. Press **Enter** in the keypad to accept the value.
5. Repeat steps 2 through 4 until all 5 custom buffer beakers are populated with desired values.
6. To modify the value entered, touch the particular beaker and key in the new value using keypad.
7. To clear all custom buffer values, touch **CLEAR**.



pH Setup: Select Auto Read Mode

XL15, 20, 25, 50 and 60 meters

Select Buffer Recognition

This option allows you to select Automatic buffer recognition or manual buffer recognition when standardizing. With the automatic buffer recognition activated, the meter will automatically recognize the buffers from the chosen buffer group and accept them when the meter recognizes the reading as stable. When in the Manual buffer recognition mode, you must enter the buffer value during the standardization procedure. The meter will accept the manually entered buffer when you recognize that the measurement is stable. During the standardization procedure, you may accept the buffer value before the meter recognizes it as stable by touching the Standardization button.

To select Buffer Recognition

1. Touch **MANUAL** or **AUTO** to choose the method of buffer selection



Select Auto Read Mode

You can use this meter when the Auto Read function is active or when it is inactive. When the Auto Read function is active, the meter will lock onto a reading when the meter recognizes it as stable. The meter will not deviate from this reading until Measure is touched. If the Auto Read function is inactive, then the meter will continuously monitor the pH of the sample and the Measure screen display will indicate any fluctuation in the sample pH.

To select Auto Read Mode

1. Touch **MANUAL** or **AUTO** to choose the desired read mode.



pH Setup: Set Default Temperature

XL15, 20, 25, 50 and 60 meters

Set pH Stability Criteria

This setup screen allows you to determine how quickly the meter will respond to electrode drift. There are 3 speed settings: fast, medium and slow

To set pH Stability Criteria

1. Touch **FAST**, **MEDIUM**, **SLOW** to choose the desired stability criteria.

pH Stability Criteria

Stability criteria are more stringent at the slower setting. Therefore, if the highest precision is required, then a slow setting would be desired. The default setting is the FAST and this should be adequate for the majority of applications without making any changes.

Set Default Temperature

It is a well known fact that pH is a temperature dependent measurement. The factory default setting is 25°C. If you are taking the pH of a solution that is not 25°C and you are not using an Automatic Temperature Compensation (ATC) probe, then you should enter the temperature value of that solution in order to get the correct pH value. The current default temperature setting will be displayed on the screen.

The default temperature can be set from -5°C to 105°C.

To set Default Temperature

1. Select temperature units by touching the appropriate unit button: **C** (Celsius), **F** (Fahrenheit) or **K** (Kelvin)
2. Touch the **Default Temperature** box and use the numeric keypad to enter the desired default temperature (-5°C to 105°C).
3. Press **Enter** in the keypad to return to pH (pH FET) Setup screen

Default Temperature

The use of an ATC probe provides a measured temperature value to the meter and will override any value entered in the default temperature screen. This measured value will be used by the meter to make pH calculations.

pH Setup: Set Alarm Limits

XL15, 20, 25, 50 and 60 meters

To set Isopotential Point

The isopotential point is the millivolt reading for an electrode at which temperature has no effect on the measurement. pH electrodes are constructed so that the isopotential point is theoretically zero millivolts. This is very close to a pH of 7. Most pH electrodes do not achieve this value precisely. However they are close enough so that it is not usually necessary to use an isopotential point other than zero. The true isopotential point of any given electrode must be determined experimentally. (See Appendix: Determining Isopotential Points Experimentally).

The isopotential point can be set from -100 to +100.

To set Isopotential Point

1. Touch the **Isopotential Point** box and use the numeric keypad to enter the desired mV setting for the new isopotential point.
2. Touch **Enter** to accept this value and return to pH (pH FET) Setup screen.

Isopotential Point	0.0	mV
--------------------	-----	----

To set Alarm Limits

This option allows you to set alarm limits for the pH measuring mode. If the pH value of the measurement is outside of the boundaries set by the minimum and maximum limits, audible and visual warnings will let you know that your sample measurement was outside of the set limits.

For the pH mode, the alarm limit can be set from -2 pH to 20 pH. As for the pH (FET) mode, the alarm limit can be set from 0 pH to 14 pH.

To set Alarm Limits

1. Touch **ON** or **OFF** to set the status of the alarm of pH (pH FET) mode
2. Touch the **Low** box and use keypad to enter the new limit values.
3. Touch **Enter** on the keypad to accept this limit and return to the pH (pH FET) Setup screen.
4. Touch the **High** box and use keypad to enter the new limit values.
5. Touch **Enter** on the keypad to accept this limit and return to the pH (pH FET) Setup screen.

Alarm Limits	ON Low	-2.00	pH
	OFF High	20.00	pH

pH Setup: Set Print Criteria

XL15, 20, 25, 50 and 60 meters

This screen allows you to select which criteria are printed with the measurement when you print the data. The status of the current print criteria is displayed on the screen. The criteria option is active if **ON** appears to the right of the option. It is inactive if **OFF** appears to the right of the option. Any active criteria will be printed on demand.

To set Print Criteria

1. Touch the **Touch here to edit** button next to the Print Criteria to access the pH Print Criteria Setup screen.
2. Touch **ON** or **OFF** to change the status of a criteria you want to modify.
3. Repeat step 2 for all the remaining criteria except Print Interval (*or Print Option*).
4. For Print Interval (*or Print Option*) select between **Log Data** and **Timed**. If “Log Data” is selected, clicking on the “Print” button from the Measurement screen will send the logged data to the printer. If “Timed” is selected, you can print data at an interval you select. This data is buffered and is sent to the printer when the page is full.
5. Touch **OK** button to accept the changes of the entire group of print criteria and return to the pH (pH FET) Setup screen.



pH Print Criteria Setup

Date / Time / Channel	ON	OFF
Sample ID	ON	OFF
Temperature	ON	OFF
Last Standardization	ON	OFF
Current Buffers	ON	OFF
Slope	ON	OFF
mV Measurement	ON	OFF
Meter Model / Serial No.	ON	OFF
Operator	ON	OFF
Print Interval	LOG DATA	TIMED

OK **Cancel** **Help**

pH Setup: Set Data Storage Criteria

XL15, 20, 25, 50 and 60 meters

This screen allows you to select which criteria are stored in the data logger with the measurement when you store the data. The status of the current data storage criteria is displayed on the screen. The criteria option is active if ON appears to the right of the option. It is inactive if OFF appears to the right of the option. Any active criteria will be stored on demand.

To set Data Storage Criteria

1. Touch the **Touch here to edit** button next to the Data Storage Criteria to access the pH Data Storage Setup screen.
2. Touch **ON** or **OFF** to change the status of a criteria you want to modify.
3. Repeat step 1 for all the remaining criteria except Data logging Interval (*or Data storage Interval*).
4. For Data logging Interval (*or Data storage Interval*), touch **MANUAL** to log pH data only when the **Log Data** button is pushed, touch **STABLE** to automatically log pH data when the pH reading is stable, or touch **TIMED** to set a specific timed interval in seconds to log pH data.
5. Touch the **OK** button to accept the changes of the entire group of data storage criteria and return to the pH (pH FET) Setup screen.

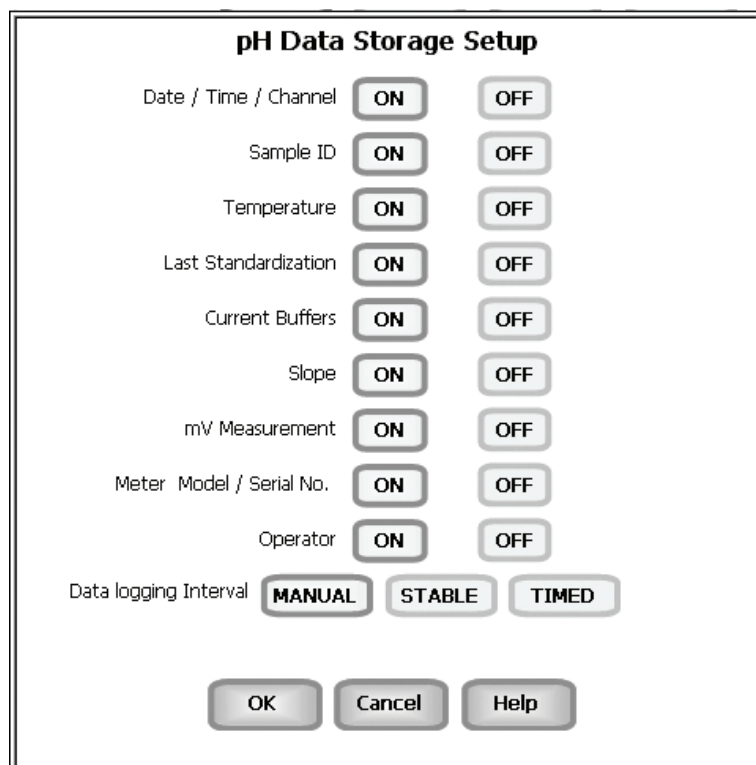

pH Setup: Set Display Criteria

XL15, 20, 25, 50 and 60 meters

This screen allows you to choose what information you would like to be displayed on the pH Measure screen, particularly the information contained in the data box at the bottom of the Measurement screen. The status of the current display criteria is displayed on the screen. The criteria option is active if **ON** appears to the right of the option. It is inactive if **OFF** appears to the right of the option.

To set Display Criteria

1. Touch the **Touch here to edit** button next to the Display Criteria to access the pH Display Criteria Setup screen.
2. Touch **ON** or **OFF** to change the status of a criteria you want to modify.
3. Repeat step 2 for all the remaining criteria except Display Resolution.
4. For Display Resolution, touch **X.X** to display pH with one decimal place, touch **X.XX** to display pH with two decimal places, or touch **X.XXX** to display pH with three decimal places.
5. Touch the **OK** button to accept the changes of the entire group of display criteria and return to the pH (pH FET) Setup screen.

Display Criteria Touch here to edit

pH Display Criteria Setup

Measurement Channel	<input type="button" value="ON"/>	<input type="button" value="OFF"/>	
Last Standardization	<input type="button" value="ON"/>	<input type="button" value="OFF"/>	
Sample ID	<input type="button" value="ON"/>	<input type="button" value="OFF"/>	
Auto Buffer Status	<input type="button" value="ON"/>	<input type="button" value="OFF"/>	
Auto Read Status	<input type="button" value="ON"/>	<input type="button" value="OFF"/>	
Temperature	<input type="button" value="ON"/>	<input type="button" value="OFF"/>	
Slope	<input type="button" value="ON"/>	<input type="button" value="OFF"/>	
Offset	<input type="button" value="ON"/>	<input type="button" value="OFF"/>	
mV Display	<input type="button" value="ON"/>	<input type="button" value="OFF"/>	
Display Resolution	<input type="button" value="X.X"/>	<input type="button" value="X.XX"/>	<input type="button" value="X.XXX"/>

pH Setup: View Stored Data

XL15, 20, 25, 50 and 60 meters

The XL15, XL20, XL25, XL 50 and XL60 have a memory capacity to store up to 1000 data points. The View Stored Data screen allows you to look at specific data points stored in the meter based on the meters memory capacity.

The meter stores pH or pH (FET) data under the following parameters:

Reading	mV Measurement
Date / Time / Channel	Slope
Sample Id	Last Standardizations
Temperature	Meter Model / Serial No
Current Buffers	Operator

To View Stored Data

1. Touch the **View** button in the pH Setup screen.



You can only log 1000 data points at a time. To clear space for new data points, you have to delete the same number of old data points as you want to add new data points.

Function buttons on View Stored Data Screen

Touch **OK** to go back to the pH Setup screen from the View Stored Data screen.

When you touch the **Help** button, information about the current screen appears. This information includes step-by-step instructions for operating the meter from the current screen and possible applications information for that screen.

Touch **Delete** to delete a selected data point from the list. To delete a data point, first touch the data point you want to delete then touch the Delete button.

Touch **Delete All** to delete all the data point in the memory.

Touch **Print** to print all the data points in the memory.

See next page on **Export View and Header (or Export View)** for explanation.

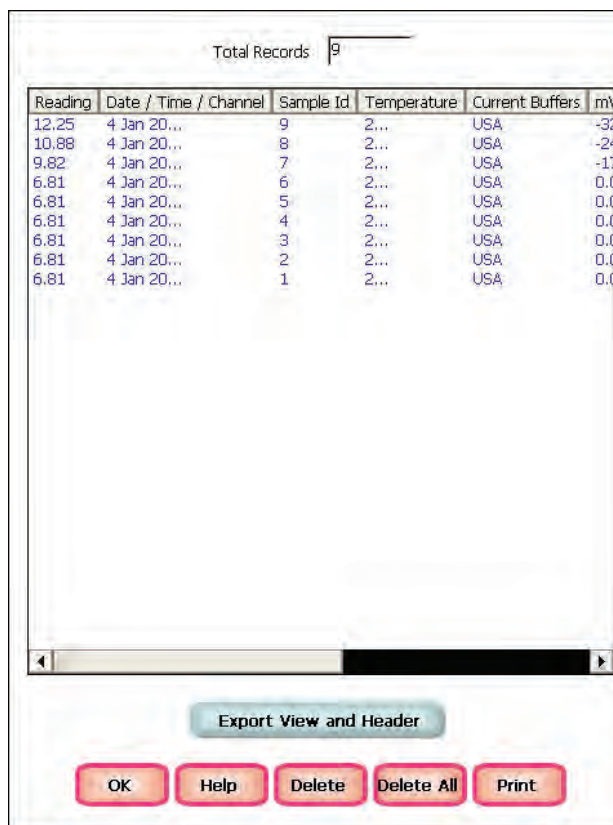

pH Setup: View Stored Data

XL15, 20, 25, 50 and 60 meters

Touch **Export View** and **Header (or Export View)** to save your data in HTML format. The file can be stored in either the Nand flash, SD Card or any of the other available locations as shown in the window. After having selected the path, touch the alphanumeric keypad to name your file.

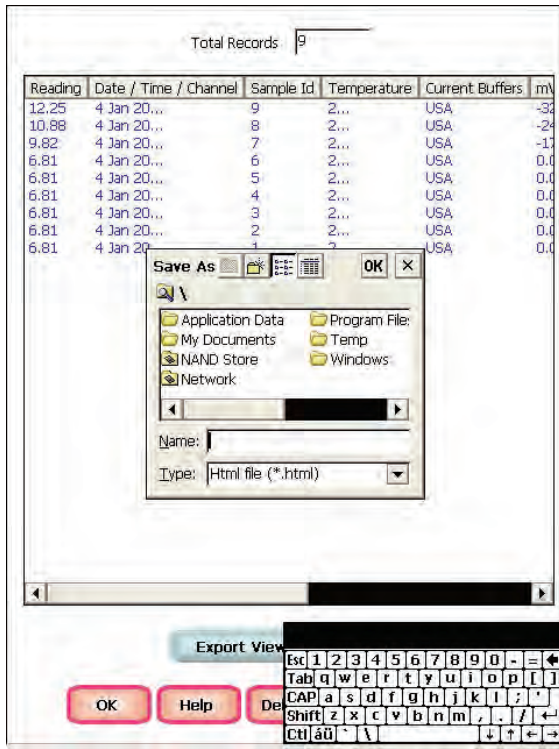

Touch the alphanumeric keypad to name your file.

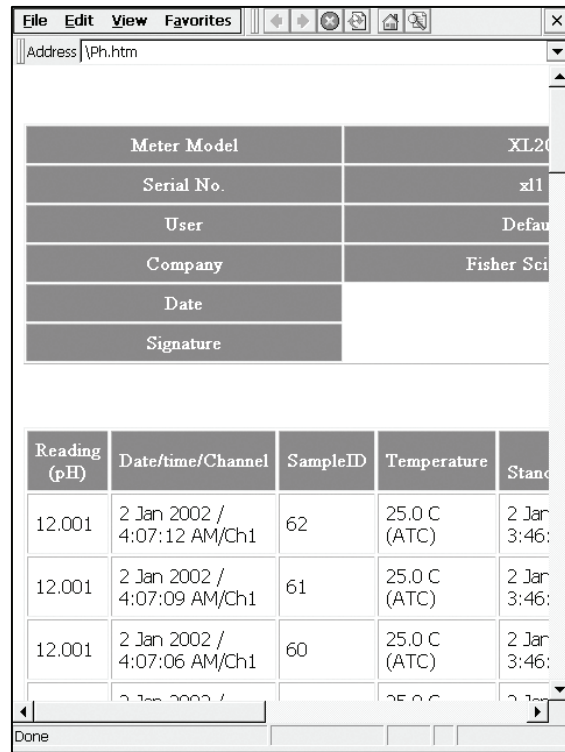

Export view in HTML format

mV Setup: mV Setup Screen

XL15, 20, 25, 50 and 60 meters

Available in XL15, XL20, XL25, XL 50 and XL60 meters, the mV Setup screen presents many options to control the operating parameters of the meter. The meter is factory set with regard to these options, and is ready for use under most circumstances (see '**Appendix: XL Series Meters Factory Default Settings**' section for default settings). The mV Setup section will guide you through the various options available in the mV setup mode.

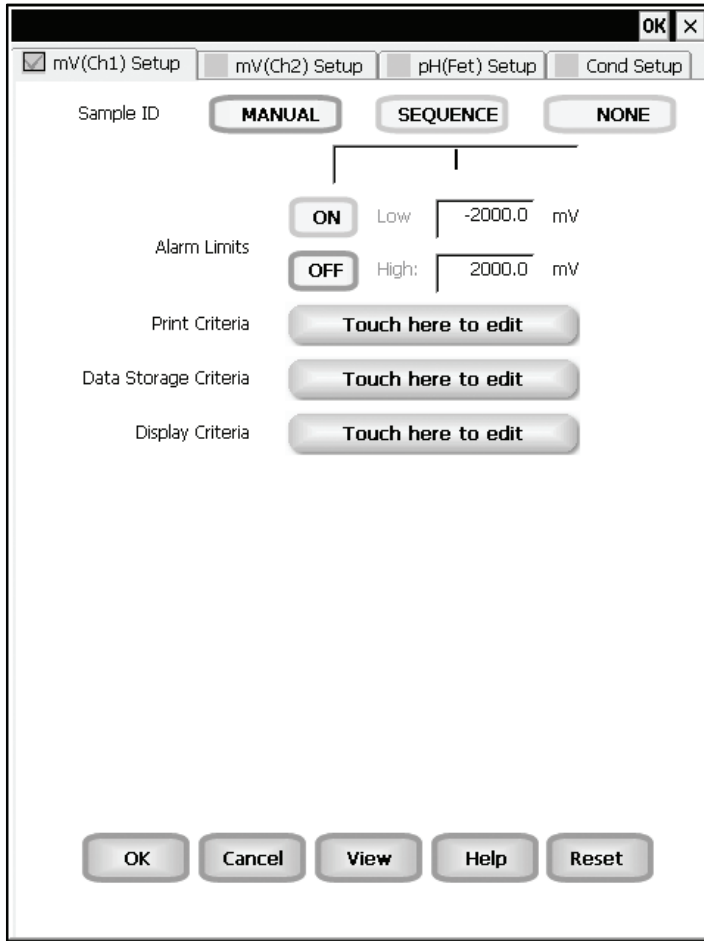

Example: - XL60 mV Setup screen

Function buttons on mV Setup Screen

Touch **OK** to confirm mV Setup and return to the mV Measure screen.

Touch **Cancel** to exit and return to the mV Measure screen without confirming mV Setup.

Touch **View** to view all mV data points stored in memory. See '**mV Setup: View Stored Data**' section for details.

When you touch the **Help** button, information about the current screen appears. This information includes step-by-step instructions for operating the meter from the current screen and possible applications information for that screen.

Touch **Reset** to reset all mV Setup Criteria to the factory default.

mV Setup: Access mV Setup

XL15, 20, 25, 50 and 60 meters

To access the Setup screen:

1. Make sure you are in the mV Measure screen.
2. Touch the **Setup** button to access the mV Setup screen.

If you were in quadruple, triple or dual display mode, you have access to the Setup mode for each channel displayed. Touch the **Setup Channel** buttons at the top of the screen to toggle back and forth between the setup screens for each channel. To change mV parameters, select the mV Setup button.



If you were in single display mode, you will access the Setup mode for the single channel displayed only.



mV Setup: Set Sample ID#

XL15, 20, 25, 50 and 60 meters

A sample ID is required if you wish to log data or activate a timed printing. Whenever this option is active, each time you touch Log Data on the mV Measure screen, the mV value along with date/time/channel and the sample ID will be sent to data storage.

You can manually enter an alphanumeric identification number of 10 characters for any sample or you can have the meter sequentially number your samples beginning at the number of your choice. You can also choose to deactivate the sample ID.

To set sample ID — Manual:

1. Touch **Manual** for manual Sample ID entry.
2. The current ID is displayed on the screen.
3. Use the alphanumeric keypad on the screen to enter the desired Sample ID. The **BS** key will allow you to backspace to remove a character that was incorrectly entered.
4. Touch **Enter** to accept current Sample ID and return to the mV Setup screen.

To set sample ID — Sequential

1. Touch **Sequence** for sequential Sample ID entry
2. The current ID is displayed on the screen
3. Use the numeric keypad on the screen to enter the desired Sample ID number that you would like your sequential Sample ID assignment to begin with. Every time you touch **Print** or **Log Data** on the pH Measure screen, the Sample ID will increase by 1. The **BS** key will allow you to backspace to remove a character that was incorrectly entered.
4. Touch **Enter** to accept the first sequential Sample ID and return to the mV Setup screen.

To deactivate the sample ID assignment — None

1. Touch None to deactivate the sample ID assignment

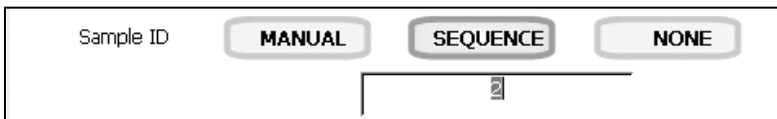

mV Setup: Set Alarm Limits

XL15, 20, 25, 50 and 60 meters

This option allows you to set alarm limits for the mV measuring mode. If the mV value of the measurement is outside of the boundaries set by the minimum and maximum limits, audible and visual warnings will let you know that your sample measurement was outside of the set limits.

The Alarm Limit can be set from -2000.0 mV to 2000.0 mV

To set Alarm Limits

1. Touch **ON** or **OFF** to set the status of the alarm of mV mode
2. Touch the **Low** box and use keypad to enter the new limit values.
3. Touch **Enter** on the keypad to accept this limit and return to the mV Setup screen.
4. Touch the **High** box and use keypad to enter the new limit values.
5. Touch **Enter** on the keypad to accept this limit and return to the mV Setup screen.

Alarm Limits	<input type="button" value="ON"/>	Low	<input type="text" value="-2000"/>	mV
	<input type="button" value="OFF"/>	High:	<input type="text" value="2000"/>	mV

mV Setup: Set Print Criteria

XL15, 20, 25, 50 and 60 meters

This screen allows you to select which criteria are printed with the measurement when you print the data. The status of the current print criteria is displayed on the screen. The criteria option is active if **ON** appears to the right of the option. It is inactive if **OFF** appears to the right of the option. Any active criteria will be printed on demand.

To set Print Criteria

1. Touch the **Touch here to edit** button next to the Print Criteria to access the mV Print Criteria Setup screen.
2. Touch **ON** or **OFF** to change the status of a criteria you want to modify.
3. Repeat step **2** for all the remaining criteria except Print Interval (*or Print Option*).
4. For Print Interval (*or Print Option*), select between **Log Data** and **Timed**. If “Log Data” is selected, clicking on the “Print” button from the Measurement screen will send the logged data to the printer. If “Timed” is selected, you can print data at an interval you select. This data is buffered and is sent to the printer when the page is full.
5. Touch **OK** button to accept the changes of the entire group of print criteria and return to the mV Setup screen.

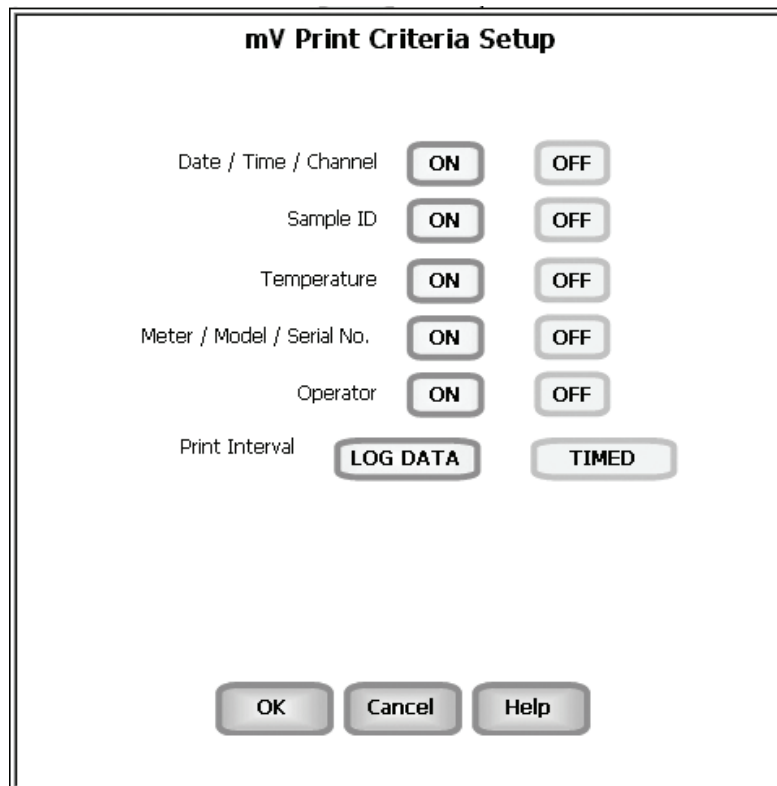

mV Setup: Set Data Storage Criteria

XL15, 20, 25, 50 and 60 meters

This screen allows you to select which criteria are stored in the data logger with the measurement when you store the data. The status of the current data storage criteria is displayed on the screen. The criteria option is active if **ON** appears to the right of the option. It is inactive if **OFF** appears to the right of the option. Any active criteria will be stored on demand.

To set Data Storage Criteria

1. Touch the **Touch here to edit button** next to the Data Storage Criteria to access the pH Data Storage Setup screen.
2. Touch **ON** or **OFF** to change the status of a criteria you want to modify.
3. Repeat step 2 for all the remaining criteria except Data logging Interval (*or Data storage Interval*).
4. For Data logging Interval (*or Data storage Interval*), touch **MANUAL** to log mV data only when the **Log Data** button is pushed, touch **STABLE** to automatically log mV data when mV reading is stable, or touch **TIMED** to set a specific timed interval in seconds to log mV data.
5. Touch the **OK** button to accept the changes of the entire group of data storage criteria and return to the mV Setup screen.



mV Data Storage Setup

Date / Time / Channel	<input checked="" type="checkbox"/> ON	<input type="checkbox"/> OFF	
Sample ID	<input checked="" type="checkbox"/> ON	<input type="checkbox"/> OFF	
Temperature	<input checked="" type="checkbox"/> ON	<input type="checkbox"/> OFF	
Meter / Model / Serial No.	<input checked="" type="checkbox"/> ON	<input type="checkbox"/> OFF	
Operator	<input checked="" type="checkbox"/> ON	<input type="checkbox"/> OFF	
Data logging Interval	<input checked="" type="button" value="MANUAL"/>	<input type="button" value="STABLE"/>	<input type="button" value="TIMED"/>

mV Setup: Set Display Criteria

XL15, 20, 25, 50 and 60 meters

This screen allows you to choose what information you would like to be displayed on the mV Measure screen, particularly the information contained in the data box at the bottom of the Measurement screen. The status of the current display criteria is displayed on the screen. The criteria option is active if **ON** appears to the right of the option. It is inactive if **OFF** appears to the right of the option.

To set Display Criteria

1. Touch the **Touch here to edit** button next to the Display Criteria to access the mV Display Criteria Setup screen.
2. Touch **ON** or **OFF** to change the status of a criteria you want to modify.
3. Repeat step 2 for all the remaining criteria except Display Resolution.
4. For Display Resolution, touch **X** to set display with 1 mV resolution or touch **X.X** to set display with 0.1 mV resolution.
5. Touch the **OK** button to accept the changes of the entire group of display criteria and return to the mV Setup screen.



mV Display Criteria Setup

Measurement Channel	<input type="button" value="ON"/>	<input type="button" value="OFF"/>
Sample ID	<input type="button" value="ON"/>	<input type="button" value="OFF"/>
Temperature	<input type="button" value="ON"/>	<input type="button" value="OFF"/>
Milivolt Offset	<input type="button" value="ON"/>	<input type="button" value="OFF"/>
Display Resolution	<input type="button" value="X"/>	<input type="button" value="X.X"/>

mV Setup: View Stored Data

XL15, 20, 25, 50 and 60 meters

The XL15, XL20, XL25, XL 50 and XL60 has a memory capacity to store up to 1000 data points. The View Stored Data screen allows you to look at specific data points stored in the meter based on the meters memory capacity.

The meter stores mV data under the following parameters:

Reading

Date / Time / Channel	Offset
Sample Id	Meter Model / Serial No
Temperature	Operator

To View Stored Data

1. Touch the View button in the mV Setup screen.



You can only log 1000 data points at a time. To clear space for new data points, you have to delete the same number of old data points as you want to add new data points.

Function buttons on View Stored Data Screen

Touch **OK** to go back to the mV Setup screen from the View Stored Data screen.

When you touch the **Help** button, information about the current screen appears.

This information includes step-by-step instructions for operating the meter from the current screen and possible applications information for that screen.

Touch **Delete** to delete a selected data point from the list. To delete a data point, first touch the data point you want to delete then touch the Delete button.

Touch **Delete All** to delete all the data point in the memory.

Touch **Print** to print all the data points in the memory.

See next page for **Export View and Header (or Export View)** explanation.

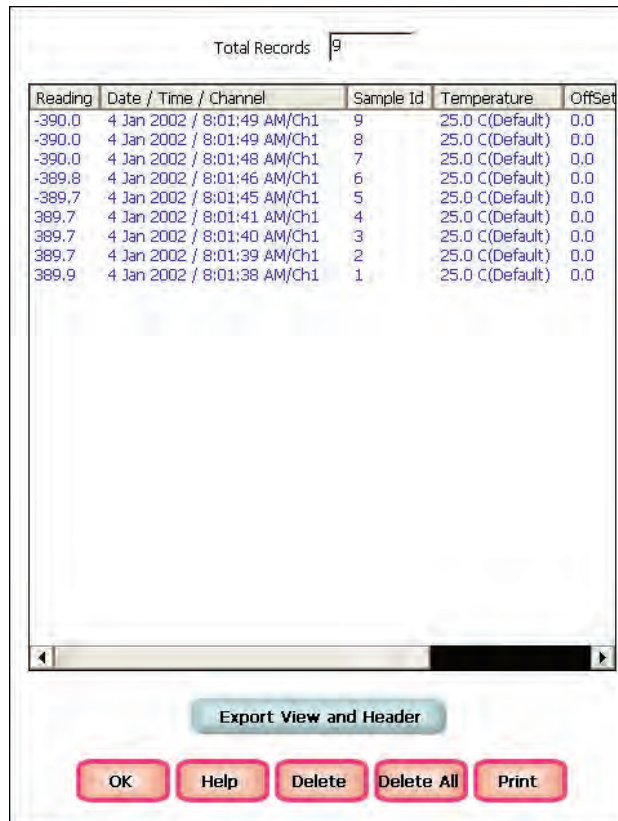

mV Setup: View Stored Data

XL15, 20, 25, 50 and 60 meters

Touch **Export View** and **Header (or Export View)** to save your data in HTML format. The file can be stored in either the Nand flash, SD Card or any of the other available locations as shown in the window. After having selected the path, touch the alphanumeric keypad to name your file.

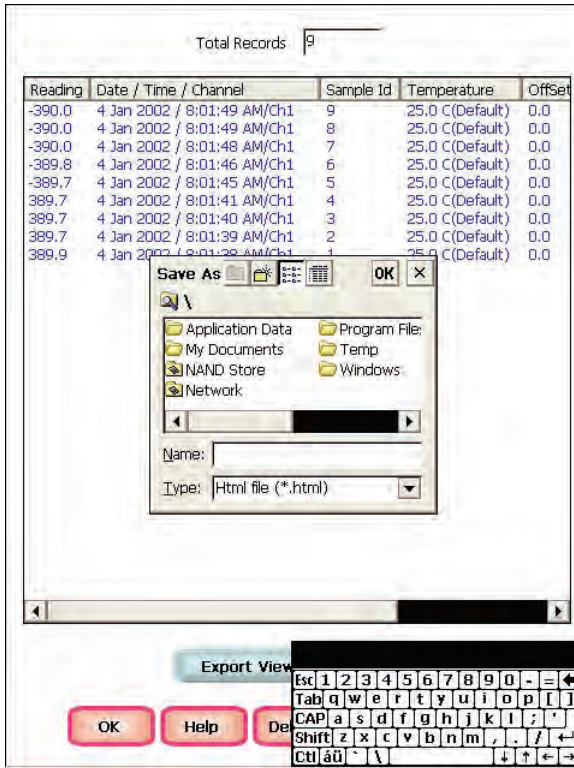

Touch the alphanumeric keypad to name your file.

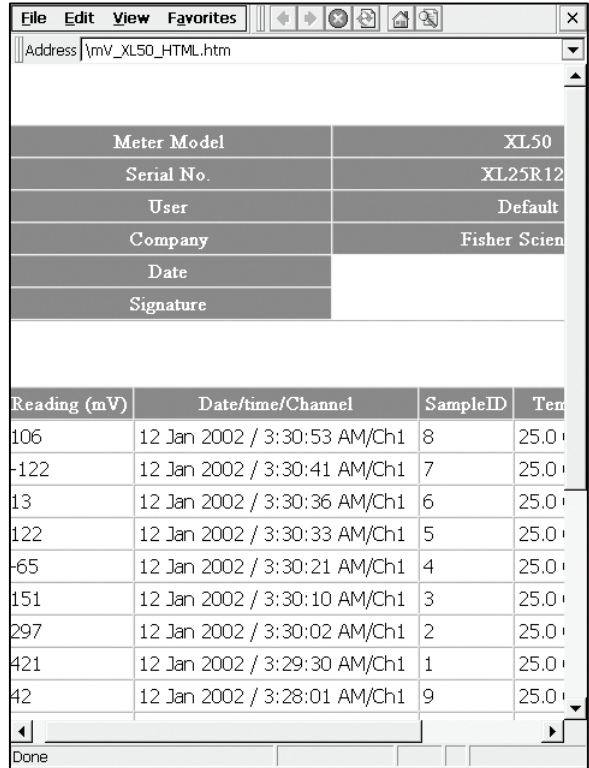

Export view in HTML format

Ion Setup: Ion Setup Screen

XL25, 50 and 60 meters

Available in XL25, XL 50 and XL60 meters, the Ion Setup screen presents many options to control the operating parameters of the meter. The meter is factory set with regard to these options, and is ready for use under most circumstances (see '[Appendix: XL Series Meters Factory Default Settings](#)' section for default settings). The operating parameters of the Ion mode can be set and controlled from the Ion setup screen. The Ion Setup section will guide you through the various options available in the Ion setup mode.

The screenshot shows the 'Ion Setup' screen for an XL60 meter. At the top, there are tabs for 'Ion(Ch1) Setup', 'pH(Ch2) Setup', 'pH(Fet) Setup', and 'Cond Setup'. The 'Ion(Ch1) Setup' tab is selected. Below the tabs, there are three buttons for 'Sample ID': 'MANUAL', 'SEQUENCE', and 'NONE'. A line connects 'MANUAL' to the 'Ion Method' dropdown menu, which is set to 'Direct Reading with Standards'. Below that is the 'Electrode Type' dropdown menu, set to 'AMMONIA'. The 'Measurement Unit' is set to 'ppm'. There are two buttons for 'Auto Read Mode': 'AUTO' and 'MANUAL'. Below that are three buttons for 'Ion Stability Criteria': 'FAST', 'MEDIUM', and 'SLOW'. The 'Default Temperature' is set to '25.0', with buttons for 'C', 'F', and 'K'. The 'Apply Temperature Compensation' has 'Yes' and 'No' buttons. The 'Isopotential Point' is set to '0.0 mV'. The 'Alarm Limits' section has 'ON' and 'OFF' buttons, and 'Low' and 'High' labels with corresponding values: '10.00 E-7' and '9.99 E10'. Below the alarm limits are three buttons: 'Touch here to edit' for 'Print Criteria', 'Data Storage Criteria', and 'Display Criteria'. At the bottom, there are five buttons: 'OK', 'Cancel', 'View', 'Help', and 'Reset'.

Example: - XL60 Ion Setup screen

Function Buttons on Ion Setup Screen

Touch **OK** to confirm Ion Setup and return to the Ion Measure screen.

Touch **Cancel** to exit and return to the Ion Measure screen without confirming Ion Setup.

Touch **View** to view all Ion data points stored in memory. See '[Ion Setup: View Stored Data](#)' section for details.

When you touch the **Help** button, information about the current screen appears. This information includes step-by-step instructions for operating the meter from the current screen and possible applications information for that screen.

Touch **Reset** to reset all Ion Setup Criteria to the factory default.

Ion Setup: Access Ion Setup

XL25, 50 and 60 meters

To access the Setup screen:

1. Make sure you are in the Ion Measure screen.
2. Touch the **Setup** button to access the Ion Setup screen.

If you were in quadruple, triple or dual display mode, you have access to the Setup mode for each channel displayed. Touch the **Setup Channel** buttons at the top of the screen to toggle back and forth between the setup screens for each channel. To change ion parameters, select the **Ion Setup** button.



If you were in single display mode, you will access the Setup mode for the single channel displayed only.



Ion Setup: Set Sample ID#

XL25, 50 and 60 meters

A sample ID is required if you wish to log data or do a timed printing. Whenever this option is active, each time you touch Log Data on the Ion Measure screen, the Ion value along with date/time/channel and the sample ID will be sent to data storage.

You can manually enter an alphanumeric identification number of 10 characters for any sample or you can have the meter sequentially number your samples beginning at the number of your choice. You can also choose to deactivate the sample ID.

To set sample ID — Manual:

1. Touch **Manual** for manual Sample ID entry
2. The current ID is displayed on the screen
3. Use the alphanumeric keypad on the screen to enter the desired Sample ID. The **BS** key will allow you to backspace to remove a character that was incorrectly entered.
4. Touch **Enter** to accept current Sample ID and return to the Ion Setup screen.

To set sample ID — Sequential

1. Touch **Sequence** for sequential Sample ID entry
2. The current ID is displayed on the screen
3. Use the numeric keypad on the screen to enter the desired Sample ID number that you would like your sequential Sample ID assignment to begin with. Every time you touch **Print** or **Log Data** on the Ion Measure screen, the Sample ID will increase by 1. The **BS** key will allow you to backspace to remove a character that was incorrectly entered.
4. Touch **Enter** to accept the first sequential Sample ID and return to the Ion Setup screen.

To deactivate the sample ID assignment — None

1. Touch **None** to deactivate the sample ID assignment



Ion Setup: Ion Method

XL25, 50 and 60 meters

The Ion Method window lets you select from a variety of ion measurement methods.

Direct Reading with Standards: The most common method of ion measurement. When using this method, you will use standards of known values to standardize the meter with ion standards. An ionic strength adjuster (ISA) is added to both the standards and the sample. Two to five standards are used. The standards should bracket the expected value of the sample. The ion specific electrode is immersed in a stirring sample and the ion concentration is read directly from the meter.

Direct Reading with Blank Offset: Commonly used for determining ion concentration in a sample with a very low level of ions. Due to background interference at low concentration levels, a blank is used and the value of the ion concentration in the blank is subtracted from the value of the measured sample.

Known Addition Method: An incremental method used for samples with a complex matrix. A standard with a known concentration of the ion species of interest is added to the sample. The difference in mV potential is then used to calculate ion concentration.

Known Subtraction Method: An incremental method where the ion of interest in the sample is not identical to the ion in the standard solution. The standard of known ion concentration that is added to the sample quantitatively reacts in the sample with the ion of interest. This reaction removes a fixed amount of the ion of interest from the sample solutions. The ion concentration is then calculated based upon the difference in the mV potential.

Analate Addition: A modification of the known addition method. The initial mV measurement is recorded in a standard solution. The ion in the standard solution is the ion of interest and is detected by the ion selective electrode in use. A sample containing the ion of interest is then added to the standard solution. The difference in the mV potential is then used in the calculation of the concentration of the ion of interest. This method is useful if the sample temperature is significantly different than that of the standard. When the small volume of hot sample is added to the larger volume, the temperature impact becomes negligible.

Analate Subtraction: Useful when there is no ion specific electrode available to directly measure the concentration of the ion of interest. This method employs the addition of a sample of the ion of interest to a standard containing a different ion of known concentration. The ion of interest will quantitatively react with the ion in the standard, creating a complex and removing the ion from the standard solution. The ion specific electrode is specific for the ion in the standard solution and not for the ion of interest. The difference in mV potential is used to calculate the concentration of the ion of interest based upon this quantitative reaction.

To select Ion Method:

1. Touch the Arrow key to the right of Ion Method
2. Touch the desired method.

Ion Method	Direct Reading with Standards ▼
------------	---------------------------------

Ion Setup: Select Electrode Type / Select Measurement Units

XL25, 50 and 60 meters

Select Electrode Type

This screen lets you select the type of electrode that is specific for your ion of interest. Your choice of electrode informs the meter which default slope to use in the calculations made for electrode efficiency and sample concentration. Once you have selected an electrode, you will not be required to enter the default slope numerically.

Note: the default slope value specific for the electrode that you choose is a theoretical slope value that is used in the calculations to determine the efficiency of your electrode. This slope value is not the slope value that is displayed in the data box of the measurement screen. You will still need to standardize the meter using ion standards to determine the actual efficiency of your electrode.

To select electrode type:

1. Touch the **Electrode Type** box to view the list of electrodes.
2. Use the scroll bar to select the desired electrode type.

Electrode Type AMMONIA ▼

Changing electrode type will erase the previous standardization.

If you are using several different electrodes, you can create a different User Profile for each electrode to save individual parameters and calibration information (i.e. "Ammonia Samples" or "Sodium Batch Testing". See '**Appendix: Setting the XL Series Meters User Profiles**' section for directions on how to set up a user profile.

Select Measurement Units

This screen lets you select the units in which the meter will report the concentration of the ion of interest. The current units are displayed on the screen.

To select measurement units:

1. Touch the **Measurement Unit** box to view the list of measurement units.
2. Use the scroll bar to select the desired units.

Once the unit has been calibrated with a particular unit of measurement, if an attempt is made to change the units, the unit comes out with a warning message: "Changing the measurement unit will erase previous standardization. Do you wish to continue?"

Measurement Unit ppm ▼

Ion Setup: Auto Read Mode / Ion Stability Criteria

XL25, 50 and 60 meters

Select Auto Read Mode

You can use this meter when the Auto Read function is active or when it is inactive. When the Auto Read function is active, the meter will lock onto a reading when the meter recognizes it as stable. The meter will not deviate from this reading until Measure is touched. If the Auto Read function is inactive, then the meter will continuously monitor the concentration of the ion of interest. The Measure screen display will indicate any fluctuation in the ion concentration.

To select Auto Read Mode

1. Touch **MANUAL** or **AUTO** to choose the desired read mode.

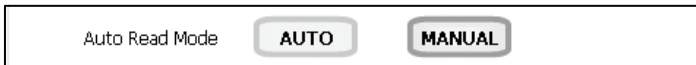

Regardless of the status of the Auto Read Mode, **STABLE** will be displayed as the meter recognizes the measurement as stable.

Set Ion Stability Criteria

This setup screen allows you to determine how quickly the meter will respond to electrode drift. There are three speed settings: fast, medium and slow

To set Ion Stability Criteria

1. Touch **FAST**, **MEDIUM**, **SLOW** to choose the desired stability criteria.



Stability criteria are more stringent at the slower setting. Therefore, if the highest precision is required, then a slow setting would be desired. The default setting is the **FAST** and this should be adequate for the majority of applications without making any changes.

Ion Setup: Set Default Temperature

XL25, 50 and 60 meters

Set Default Temperature

It is a well known fact that ion concentration is a temperature dependent measurement. The factory default setting is 25°C. If you are measuring a solution that is not 25°C and if you are not using a temperature probe, then you should enter the temperature value of that solution in order to get the correct concentration value. The current default temperature setting will be displayed on the screen.

The default temperature can be set from -5°C to 105°C.

To set Default Temperature

1. Select temperature units by touching the appropriate unit button: **C** (Celsius), **F** (Fahrenheit) or **K** (Kelvin).
2. Touch the **Default Temperature** box and use the numeric keypad to enter the desired default temperature (-5°C to 105°C).
3. Press **Enter** in the keypad to return to Ion Setup screen.

Best results are obtained when the standards and the samples are at the same temperature.

Ion Setup: Temperature Compensation/Isopotential Point/Alarm Limits XL25, 50 and 60 meters

Set Apply Temperature Compensation

Ion concentration is a temperature dependent measurement. Best results are obtained when the standards and the samples are standardized and calibrated at the same temperature. However, if you have experimentally determined the isopotential point of your electrode then you can choose to set ATC to YES and enter the isopotential value. This option is set to NO by default.

To set Apply Temperature Compensation

1. Touch **YES** to choose Apply Temperature Compensation.

Apply Temperature Compensation	<input type="button" value="Yes"/>	<input type="button" value="No"/>
--------------------------------	------------------------------------	-----------------------------------

Set Isopotential Point

The isopotential point is the millivolt reading for an electrode at which temperature has no effect on the measurement. Ion Selective Electrodes, unlike pH electrodes, are not designed to achieve any particular isopotential point. If samples and standards are at different temperatures when performing ISE experiments, it will be necessary to experimentally determine the isopotential point of your own Ion Specific Electrode.

To set Isopotential Point

1. Touch the **Isopotential Point** box and use the numeric keypad to enter the desired mV setting for the new isopotential point.
2. Touch **Enter** to accept this value and return to Ion Setup screen.

Isopotential Point	<input type="text" value="0.0"/>	mV
--------------------	----------------------------------	----

Set Alarm Limits

This option allows you to set alarm limits for the ion measuring mode. If the ion concentration value of the measurement is outside of the boundaries set by the minimum and maximum limits, a visual warning will appear to let you know that your sample measurement was outside of the set limits.

The validity range of alarm limits is 0.000001 to 99,900,000,000.

To set Alarm Limits

1. Touch **ON** or **OFF** to set the status of the alarm.
2. Touch the **Low** box and use keypad to enter the new limit values.
3. Touch **Enter** on the keypad to accept this limit and return to the Ion Setup screen.
4. Touch the **High** box and use keypad to enter the new limit values.
5. Touch **Enter** on the keypad to accept this limit and return to the Ion Setup screen.

Alarm Limits	<input type="button" value="ON"/>	Low	<input type="text" value="10.00 E-7"/>
	<input type="button" value="OFF"/>	High	<input type="text" value="9.99 E10"/>



Ion Setup: Set Print Criteria

XL25, 50 and 60 meters

This screen allows you to select which criteria are printed with the measurement when you print the data. The status of the current print criteria is displayed on the screen. The criteria option is active if **ON** appears to the right of the option. It is inactive if **OFF** appears to the right of the option. Any active criteria will be printed on demand.

To set Print Criteria

1. Touch the **Touch here to edit** button next to the Print Criteria to access the Ion Print Criteria Setup screen.
2. Touch **ON** or **OFF** to change the status of a criteria you want to modify.
3. Repeat step 2 for all the remaining criteria except Print Interval (*or Print Option*).
4. For Print Interval (*or Print Option*), select between **Log Data** and **Timed**. If “Log Data” is selected, clicking on the “Print” button from the Measurement screen will send the logged data to the printer. If “Timed” is selected, you can print data at an interval you select. This data is buffered and is sent to the printer when the page is full.
5. Touch **OK** button to accept the changes of the entire group of print criteria and return to the Ion Setup screen.



Ion Print Criteria Setup

Date / Time / Channel	ON	OFF
Sample ID	ON	OFF
Temperature	ON	OFF
Ion Method	ON	OFF
Electrode Type	ON	OFF
Last Standardization	ON	OFF
Current Standards	ON	OFF
Slope	ON	OFF
mV Measurement	ON	OFF
Meter Model / Serial No.	ON	OFF
Operator	ON	OFF
Print Interval	LOG DATA	TIMED

OK **Cancel** **Help**

Ion Setup: Set Data Storage Criteria

XL25, 50 and 60 meters

This screen allows you to select which criteria are stored in the data logger with the measurement when you store the data. The status of the current data storage criteria is displayed on the screen. The criteria option is active if **ON** appears to the right of the option. It is inactive if **OFF** appears to the right of the option. Any active criteria will be stored on demand.

To set Data Storage Criteria

1. Touch the **Touch here to edit** button next to the Data Storage Criteria to access the pH Data Storage Setup screen.
2. Touch **ON** or **OFF** to change the status of a criteria you want to modify.
3. Repeat step 2 for all the remaining criteria except Data logging Interval (*or Data storage Interval*).
4. For Data logging Interval (*or Data storage Interval*), touch **MANUAL** to store Ion data only when the **Log Data** button is pushed, touch **STABLE** to automatically store Ion data when Ion reading is stable, or touch **TIMED** to set a specific timed interval in seconds to store Ion data.
5. Touch **OK** button to accept the changes of the entire group of data storage criteria and return to the Ion Setup screen.

Data Storage Criteria

Touch here to edit

Ion Data Storage Setup

Date / Time / Channel	<input type="button" value="ON"/>	<input type="button" value="OFF"/>	
Sample ID	<input type="button" value="ON"/>	<input type="button" value="OFF"/>	
Temperature	<input type="button" value="ON"/>	<input type="button" value="OFF"/>	
Ion Method	<input type="button" value="ON"/>	<input type="button" value="OFF"/>	
Electrode Type	<input type="button" value="ON"/>	<input type="button" value="OFF"/>	
Last Standardization	<input type="button" value="ON"/>	<input type="button" value="OFF"/>	
Current Standards	<input type="button" value="ON"/>	<input type="button" value="OFF"/>	
Slope	<input type="button" value="ON"/>	<input type="button" value="OFF"/>	
mV Measurement	<input type="button" value="ON"/>	<input type="button" value="OFF"/>	
Meter Model / Serial No.	<input type="button" value="ON"/>	<input type="button" value="OFF"/>	
Operator	<input type="button" value="ON"/>	<input type="button" value="OFF"/>	
Data logging Interval	<input type="button" value="MANUAL"/>	<input type="button" value="STABLE"/>	<input type="button" value="TIMED"/>
	<input type="button" value="OK"/>	<input type="button" value="Cancel"/>	<input type="button" value="Help"/>



Ion Setup: Set Display Criteria

XL25, 50 and 60 meters

This screen allows you to choose what information you would like to be displayed on the Ion Measure screen, particularly the information contained in the data box at the bottom of the Measurement screen. The status of the current display criteria is displayed on the screen. The criteria option is active if **ON** appears to the right of the option. It is inactive if **OFF** appears to the right of the option.

To set Display Criteria

1. Touch the **Touch here to edit** button next to the Display Criteria to access the pH Display Criteria Setup screen.
2. Touch **ON** or **OFF** to change the status of a criteria you want to modify.
3. Repeat step 2 for all the remaining criteria except Display Resolution.
4. Display Resolution lets you select the number of significant figures that will be used when reporting your ion measurement. Touch **2**, **3**, or **4** to select the desired significant digits.
5. Touch **OK** button to accept the changes of the entire group of display criteria and return to the Ion Setup screen.



Ion Display Criteria Setup

Measurement Channel	<input type="button" value="ON"/>	<input type="button" value="OFF"/>	
Last Standardization	<input type="button" value="ON"/>	<input type="button" value="OFF"/>	
Sample ID	<input type="button" value="ON"/>	<input type="button" value="OFF"/>	
Standardisation Method	<input type="button" value="ON"/>	<input type="button" value="OFF"/>	
Auto Read Status	<input type="button" value="ON"/>	<input type="button" value="OFF"/>	
Temperature	<input type="button" value="ON"/>	<input type="button" value="OFF"/>	
Slope	<input type="button" value="ON"/>	<input type="button" value="OFF"/>	
Electrode Type	<input type="button" value="ON"/>	<input type="button" value="OFF"/>	
mV Display	<input type="button" value="ON"/>	<input type="button" value="OFF"/>	
Display Resoultion	<input type="button" value="2"/>	<input type="button" value="3"/>	<input type="button" value="4"/>

Ion Setup: View Stored Data

XL25, 50 and 60 meters

The XL series meters have a memory capacity to store up to 1000 data points. The View Stored Data screen allows you to sort and look at specific data points stored in the meter based on the meters memory capacity. The stored data can be sorted by any of the parameters available in the screen header.

The meter stores Ion data under the following parameters:

Reading	mV measurement
Date / Time / Channel	Slope
Sample Id	Last Standardization
Temperature	Meter Model/Serial No
Current Buffers	Operator

To View Stored Data

1. Touch the **View** button in the mV Setup screen.



You can only log 1000 data points at a time. To clear space for new data points, you have to delete the same number of old data points as you want to add new data points.

Function buttons on View Stored Data Screen

Touch **OK** to go back to the Ion Setup screen from the View Stored Data screen.

When you touch the **Help** button, information about the current screen appears. This information includes step-by-step instructions for operating the meter from the current screen and possible applications information for that screen.

Touch **Delete** to delete a selected data point from the list. To delete a data point, first touch the data point you want to delete then touch the **Delete** button.

Touch **Delete All** to delete all the data point in the memory.

Touch **Print** to print all the data points in the memory.

See next page for **Export View and Header (or Export View)** explanation.

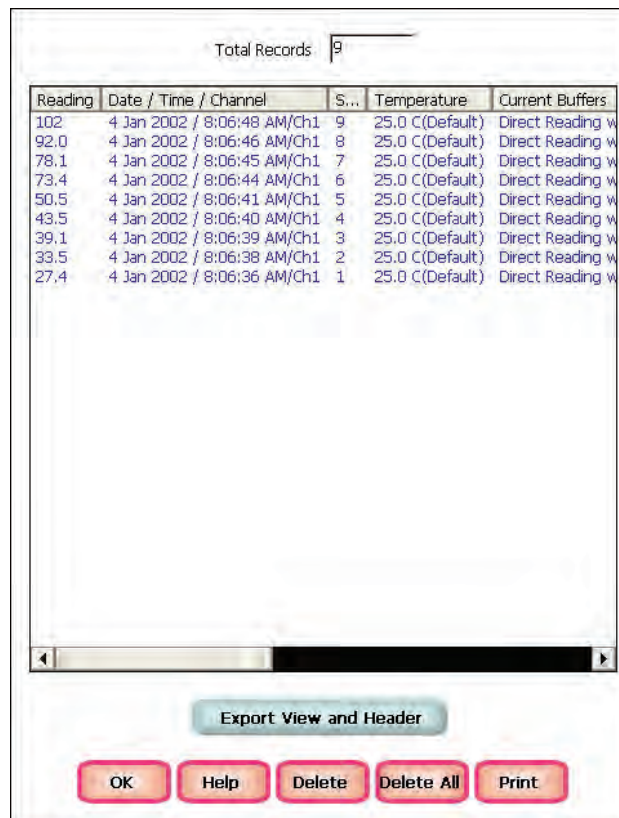

Ion Setup: View Stored Data XL25, 50 and 60 meters

Touch **Export View** and **Header (or Export View)** to save your data in HTML format. The file can be stored in either the Nand flash, SD Card or any of the other available locations as shown in the window. After having selected the path, touch the alphanumeric keypad to name your file.

The screenshot shows the software interface with a data table and a 'Save As' dialog box. The data table has the following columns: Reading (Ion), Date/time/Channel, SampleID, Temperature, and I Stand. The 'Save As' dialog box shows a file explorer view with folders like Application Data, My Documents, NAND Store, Program File, Temp, and Windows. An alphanumeric keypad is overlaid on the bottom of the screen.

Reading	Date / Time / Channel	S...	Temperature	Current Buffers
102	4 Jan 2002 / 8:06:48 AM/Ch1	9	25.0 C(Default)	Direct Reading w
92.0	4 Jan 2002 / 8:06:46 AM/Ch1	8	25.0 C(Default)	Direct Reading w
78.1	4 Jan 2002 / 8:06:45 AM/Ch1	7	25.0 C(Default)	Direct Reading w
73.4	4 Jan 2002 / 8:06:44 AM/Ch1	6	25.0 C(Default)	Direct Reading w
50.5	4 Jan 2002 / 8:06:41 AM/Ch1	5	25.0 C(Default)	Direct Reading w
43.5	4 Jan 2002 / 8:06:40 AM/Ch1	4	25.0 C(Default)	Direct Reading w
39.1	4 Jan 2002 / 8:06:39 AM/Ch1	3	25.0 C(Default)	Direct Reading w
33.5	4 Jan 2002 / 8:06:38 AM/Ch1	2	25.0 C(Default)	Direct Reading w
27.4	4 Jan 2002 / 8:06:36 AM/Ch1	1	25.0 C(Default)	Direct Reading w

Reading (Ion)	Date/time/Channel	SampleID	Temperature	I Stand
32.88	26 Jul 2004 / 4:22:41 AM/Ch1	9	25.0 C (Default)	26 Jul 3:57:3
42.55	26 Jul 2004 / 4:22:26 AM/Ch1	8	25.0 C (Default)	26 Jul 3:57:3
54.62	26 Jul 2004 / 4:22:16 AM/Ch1	7	25.0 C (Default)	26 Jul 3:57:3

Touch the alphanumeric keypad to name your file.

Export view in HTML format

DO Setup: DO Setup Screen XL40 and 60 meters

The XL40 and XL60 meter allows you to measure DO, BOD, OUR and SOUR. Each mode is independent from one another and needs to be setup separately. However the basic setup procedure is virtually identical for each mode with exceptions noted. This manual will focus on DO Setup screens, but each mode will setup in the same manner. BOD, OUR and SOUR have a configuration to edit in the setup mode, see BOD, OUR and SOUR Setup.

The DO Setup screen present many options to control the operating parameters of the meter. The meter is factory set with regard to these options, and is ready for use under most circumstances (see '**Appendix: XL Series Meters Factory Default Settings**' section for default settings). The operating parameters of the DO mode can be set and controlled from the DO setup screen. The DO Setup section will guide you through the various options available in the DO setup mode.

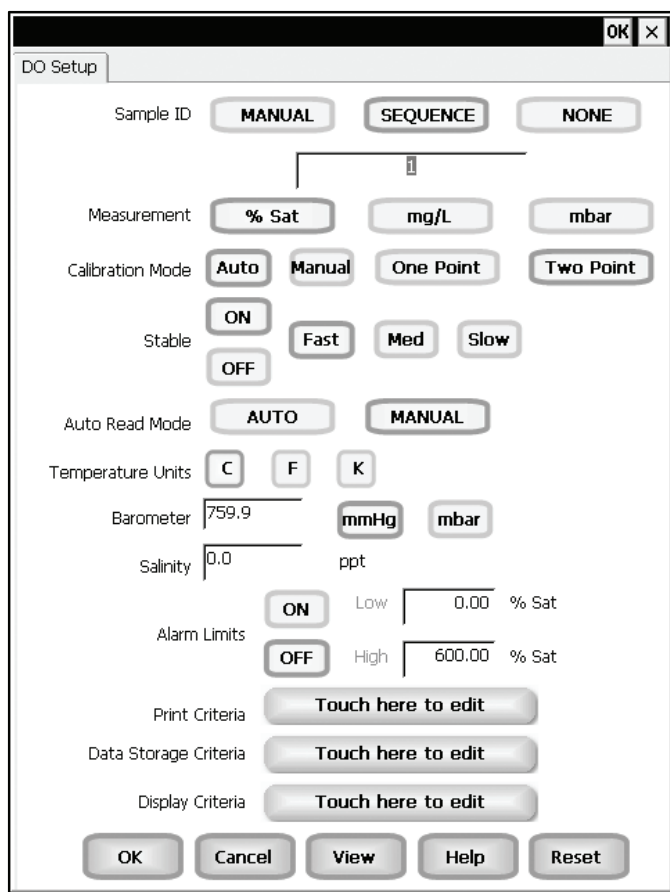

Example: - XL60 DO Setup screen

Function Buttons on DO Setup Screen

Touch **OK** to confirm DO Setup and return to the DO Measure screen.

Touch **Cancel** to exit and return to the DO Measure screen without confirming DO Setup.

Touch **View** to view all DO data points stored in memory. See '**DO Setup: View Stored Data**' section for details.

When you touch the **Help** button, information about the current screen appears. This information includes step-by-step instructions for operating the meter from the current screen and possible applications information for that screen.

Touch **Reset** to reset all DO Setup Criteria to the factory default.

DO Setup: Access DO Setup XL40 and 60 meters

To access the Setup screen:

1. Make sure you are in the Dissolved Oxygen Measure.
2. Touch the **Setup** button to access the Dissolved Oxygen Setup screen.

If you were in quadruple, triple or dual display mode, you have access to the Setup mode for each channel displayed. Touch the **Setup Channel** buttons at the top of the screen to toggle back and forth between the setup screens for each channel. To change DO parameters, select the DO Setup button.



If you were in single display mode, you will access the Setup mode for the single channel displayed only.



DO Setup: Set Sample ID

XL40 and 60 meters

You can manually enter an alphanumeric identification number of 10 characters for any sample or you can have the meter sequentially number your samples beginning at the number of your choice. You can also choose to deactivate the sample ID.

To set sample ID — Manual:

1. Touch **Manual** for manual Sample ID entry.
2. The current ID is displayed on the screen.
3. Use the alphanumeric keypad on the screen to enter the desired Sample ID. The **BS** key will allow you to backspace to remove a character that was incorrectly entered.
4. Touch **Enter** to accept current Sample ID and return to the Setup screen.

To set sample ID — Sequential

1. Touch **Sequential** for sequential Sample ID entry.
2. The current ID is displayed on the screen.
3. Use the numeric keypad on the screen to enter the desired Sample ID number that you would like your sequential Sample ID assignment to begin with. Every time you touch **Print** or **Log Data** on the Measure screen, the Sample ID will increase by 1. The **BS** key will allow you to backspace to remove a character that was incorrectly entered.
4. Touch **Enter** to accept the first sequential Sample ID and return to the Setup screen.

To deactivate the sample ID assignment — None

1. Touch **None** to deactivate the sample ID assignment.

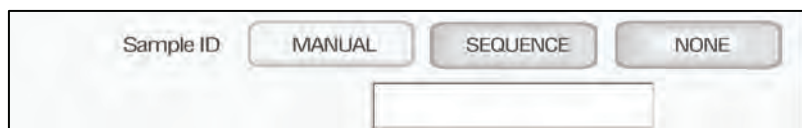

DO Setup: Select Measurement Units / Select Calibration Mode XL40 and 60 meters

Select Measurement Units

This setup option allows you to select the units of measurement for DO. Choose between % Saturation, mg/L or mbar.

To select Measurement Units

1. Touch **% Sat**, **mg/L** or **mbar** to choose the units of measurement.



NOTE: In OUR and SOUR setup modes, the measurement unit cannot be changed.

Select Calibration Mode

This option allows you to select Automatic standard recognition or manual standard recognition when standardizing. With the automatic standard recognition activated, the meter will automatically recognize the standard from the preset group depending upon the measurement unit selected (see below) and accept them when the meter recognizes the reading as stable. When in the Manual standard recognition mode, you must enter the standard value during the standardization procedure. The meter will accept the manually entered standard once the measurement is stable.

This option also allows you to choose one point or two point standardization.

To select Standard Recognition

1. Touch **Auto** or **Manual** to choose the method of standard recognition.

To select Standardization Points

1. Touch **Single Point** or **Multi Point** to choose the method of standardization.



% Saturation Calibration Mode Options

- Auto calibration and one point (100% saturation)
- Auto calibration and two point (0 and 100% saturation)
- Manual calibration and one point

mg/L Calibration Mode Options

- Auto calibration and one point (8.26 mg/L)
- Manual calibration and one point

There are no calibration options for mbar.

DO Setup: Select Stable Indicator / Select Auto Read Mode

XL40 and 60 meters

Select Stable indicator

This setup option also lets you turn **ON** or **OFF** the stability indicator. When this function is turned on, the **STABLE** appears when the DO reading is stable. This option also allows the user to choose how fast (**Fast**, **Med** and **Slow**) the meter will accept a measurement or standardization as stable. Choosing the **Slow** setting requires the meter to wait a longer time period before accepting the measurement as stable, this reflects the highest level of precision.

To select Stable indicator

1. Touch **ON** or **OFF** to turn stable indicator on or off.

To select Stable indicator speed

1. Touch **Fast**, **Med** or **Slow** to select the stability indicator speed.



Select Auto Read Mode

This setup option allows you to select the activity of the Auto read mode. If the Auto read is active (**AUTO**), the meter will freeze the reading on the screen when the measurement becomes stable. To unfreeze the reading the **Measure** button must be pressed. If the Auto read is inactive (**MANUAL**), the meter provides continuous monitoring of the sample. The stable indicator will appear in manual read mode if the measurement is stable and the stable indicator is turned "**ON**" but will not freeze the reading if there is any fluctuations in that reading.

To select Auto Read Mode

1. Touch **AUTO** or **MANUAL** to choose the desired read mode.



NOTE: In BOD, OUR and SOUR setup modes, the Auto/Manual Read Mode is not available. See BOD, OUR and SOUR Setup for details.

DO Setup: Select Temperature Units / Select Barometer

XL40 and 60 meters

Select Temperature Units

This setup function allows you to choose the temperature units show in the measurement screen (celsius, fahrenheit or Kelvin).

To select Temperature Units

1. Select temperature units by touching the appropriate unit button: **C** (Celsius), **F** (Fahrenheit) or **K** (Kelvin).



Set Barometer

The XL40 and XL60 meters use an internal barometric pressure sensor in both the auto and manual calibration mode. Prior to calibration check the actual barometric pressure. If this value is different than the current barometric pressure displayed on the XL40 and XL60, you must calibrate the internal barometer. See below to set the barometer. **DO NOT** use the barometric pressure issued by the weather service since this value is adjusted to sea level.

The barometer can be set from 450 to 825 mmHg or 599 to 1099 mbar.

To set Barometer

1. Touch **mmHg** or **mbar** to choose desired barometric units.
2. The current internal barometric pressure value is displayed on the **Barometer** box.
3. Touch the **Barometer** box and use the numeric keypad on the screen to enter the actual barometric pressure. The **BS** key allows you to remove characters that are incorrectly entered.
4. Touch **Enter** on the keypad to accept the barometric pressure value and return to the Setup screen.



DO Setup: Set Salinity / Set Alarm Limits

XL40 and 60 meters

Set Salinity

Water containing high levels of dissolved salts reduces dissolved oxygen in that water versus water with little or no dissolved salts. The dissolved salts alter the relationship between the partial pressure of oxygen and the oxygen concentration in water. By setting the salinity (in ppt) of your sample, the XL40 and XL60 meter will compensate for the impact of salinity on the partial pressure/oxygen concentration relationship of your sample.

The salinity can be set from 0 to 45 ppt.

To set Salinity

1. The current internal salinity value is displayed on the **Salinity box**.
2. Touch the **Salinity box** and use the numeric keypad on the screen to enter the salinity of your sample. The **BS** key allows you to remove characters that are incorrectly entered.
3. Touch **Enter** on the keypad to accept the salinity value and return to the Setup screen.

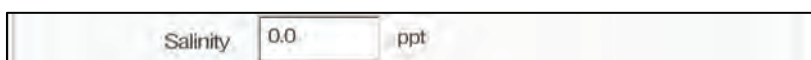

A screenshot of the Salinity input field. It shows a label 'Salinity' followed by a numeric input box containing '0.0' and a unit label 'ppt'.

Set Alarm Limits

This option allows you to set alarm limits for the DO measuring mode. If the DO value of the measurement is outside of the boundaries set by the minimum and maximum limits, an audio and visual warning will appear to let you know that your sample measurement was outside of the set limits.

The Alarm Limit can be set from 0 to 600% Sat, 0 to 60 mg/L and 0 to 1272 mbar at the atmospheric pressure of 1013 mbar.

To set Alarm Limits

1. Touch **ON** or **OFF** to set the status of the alarm of DO mode
2. Touch the **Low box** and use numeric keypad to enter the new limit values. The **BS** key allows you to remove characters that are incorrectly entered.
3. Touch **Enter** on the keypad to accept this limit and return to the Setup screen.
4. Touch the **High box** and use numeric keypad to enter the new limit values. The **BS** key allows you to remove characters that are incorrectly entered.
5. Touch **Enter** on the keypad to accept this limit and return to the Setup screen.



A screenshot of the Alarm Limits setup screen. It shows a label 'Alarm Limits' followed by two rows of controls. The first row has an 'ON' button, the label 'Low', and a numeric input box containing '0.00'. The second row has an 'OFF' button, the label 'High', and a numeric input box containing '600.00'.



DO Setup: Set Print Criteria XL40 and 60 meters

This screen allows you to select which criteria are printed with the measurement when you print the data. The status of the current print criteria is displayed on the screen. The criteria option is active if **ON** appears to the right of the option. It is inactive if **OFF** appears to the right of the option. Any active criteria will be printed on demand.

To set Print Criteria

1. Touch the **Touch here to edit** button next to the Print Criteria to access the DO Print Criteria Setup screen.
2. Touch **ON** or **OFF** to change the status of a criteria you want to modify.
3. Repeat step 2 for all the remaining criteria except Print Interval (*or Print Option*).
4. In the Print Interval (*or Print Option*):
Select **TIMED** to set the desired time interval in seconds via numeric keypad. Press **Enter** to confirm time. The **BS** key allows you to remove characters that are incorrectly entered. When **TIMED** is selected, data is sent to the printer buffer memory at the selected time intervals and once the page is full, would be sent to the printer.
OR
Select **LOG DATA** to send all data stored in the data log memory to the printer when the Print button is pushed from the measurement screen.
5. Touch the **OK** button to accept the changes of the entire group of print criteria and return to the Setup screen.



DO Print Criteria Setup

Date / Time / Channel	<input type="button" value="ON"/>	<input type="button" value="OFF"/>
Sample ID	<input type="button" value="ON"/>	<input type="button" value="OFF"/>
Temperature	<input type="button" value="ON"/>	<input type="button" value="OFF"/>
Salinity	<input type="button" value="ON"/>	<input type="button" value="OFF"/>
Barometer	<input type="button" value="ON"/>	<input type="button" value="OFF"/>
Last Standardization	<input type="button" value="ON"/>	<input type="button" value="OFF"/>
Meter Model / Serial No	<input type="button" value="ON"/>	<input type="button" value="OFF"/>
Operator	<input type="button" value="ON"/>	<input type="button" value="OFF"/>
Print Interval	<input type="button" value="LOG DATA"/>	<input type="button" value="TIMED"/>

DO Setup: Set Data Storage Criteria XL40 and 60 meters

This screen allows you to select which criteria are stored in the data logger with the measurement when you store the data. The status of the current data storage criteria is displayed on the screen. The criteria option is active if **ON** appears to the right of the option. It is inactive if **OFF** appears to the right of the option. Any active criteria will be stored on demand.

To set Data Storage Criteria

1. Touch the **Touch here to edit** button next to the Data Storage Criteria to access the DO Data Storage Criteria Setup screen.
2. Touch **ON** or **OFF** to change the status of a criteria you want to modify.
3. Repeat step **2** for all the remaining criteria except Data logging Interval (*or Data Storage Interval*).
4. For Data logging Interval (*or Data Storage Interval*), touch **MANUAL** to log DO data only when the Log Data button is pushed, touch **STABLE** to automatically log DO data when DO reading is stable, or touch **TIMED** to set a specific timed interval in seconds to log DO data.
5. Touch the **OK** button to accept the changes of the entire group of data storage criteria and return to the DO Setup screen.

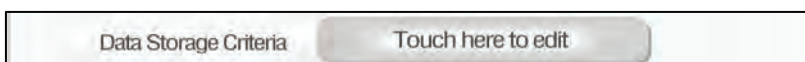

DO Data Storage Criteria Setup

Date / Time / Channel	<input checked="" type="checkbox"/> ON	<input type="checkbox"/> OFF	
Sample ID	<input checked="" type="checkbox"/> ON	<input type="checkbox"/> OFF	
Temperature	<input checked="" type="checkbox"/> ON	<input type="checkbox"/> OFF	
Salinity	<input checked="" type="checkbox"/> ON	<input type="checkbox"/> OFF	
Barometer	<input checked="" type="checkbox"/> ON	<input type="checkbox"/> OFF	
Last Standardization	<input checked="" type="checkbox"/> ON	<input type="checkbox"/> OFF	
Meter Model / Serial No	<input checked="" type="checkbox"/> ON	<input type="checkbox"/> OFF	
Operator	<input checked="" type="checkbox"/> ON	<input type="checkbox"/> OFF	
Data logging Interval	<input checked="" type="radio"/> MANUAL	<input type="radio"/> STABLE	<input type="radio"/> TIMED

DO Setup: Set Display Criteria XL40 and 60 meters

This screen allows you to choose what information you would like to be displayed on the Measure screen, particularly the information contained in the data box at the bottom of the Measurement screen. The status of the current display criteria is displayed on the screen. The criteria option is active if **ON** appears to the right of the option. It is inactive if **OFF** appears to the right of the option.

To set Display Criteria

1. Touch the **Touch here to edit** button next to the Display Criteria to access the Display Criteria Setup screen.
2. Touch **ON** or **OFF** to change the status of a criteria you want to modify.
3. Repeat step 2 for all the remaining criteria except Display Resolution.
4. For Display Resolution, touch **X** to display DO with no decimal place or touch **X.X** to display DO with one decimal place
5. Touch the **OK** button to accept the changes of the entire group of display criteria and return to the DO Setup screen.

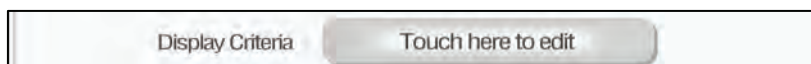

DO Display Criteria Setup

Measurement Channel	<input type="button" value="ON"/>	<input type="button" value="OFF"/>
Last Standardization	<input type="button" value="ON"/>	<input type="button" value="OFF"/>
Sample ID	<input type="button" value="ON"/>	<input type="button" value="OFF"/>
Temperature	<input type="button" value="ON"/>	<input type="button" value="OFF"/>
Salinity	<input type="button" value="ON"/>	<input type="button" value="OFF"/>
Barometer	<input type="button" value="ON"/>	<input type="button" value="OFF"/>
Standardization Mode	<input type="button" value="ON"/>	<input type="button" value="OFF"/>
Auto Read Status	<input type="button" value="ON"/>	<input type="button" value="OFF"/>
Display Resolution	<input type="button" value="X.X"/>	<input type="button" value="X.XX"/>

DO Setup: View Stored Data

XL40 and 60 meters

The XL40 and XL60 have a memory capacity to store up to 1000 data points. The View Stored Data screen allows you to sort and look at specific data points stored in the meter based on the meters memory capacity. The stored data can be sorted by any of the parameters available in the screen header.

The meter stores DO data under the following parameters:

Reading	Standardized Buffer
Date / Time / Channel	Current Buffer
Sample Id	Calibration Point
Temperature	Meter Model Serial No.
Last Standardizations	Operator

To View Stored Data

1. Touch the View button in the DO Setup screen

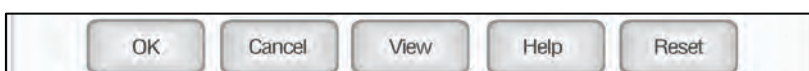

You can only log 1000 data points at a time. To clear space for new data points, you have to delete the same number of old data points as you want to add new data points.

Function buttons on View Stored Data Screen

Export View and Header is used to export the contents of the view screen as an html file to the location of your choice from the list. When touched a dialog box and alphanumeric keypad appear to select a file name and folder to save the html file. The saved data can be viewed from the desktop.

Touch **OK** to go back to the Setup screen from the View Stored Data screen.

When you touch the **Help** button, information about the current screen appears. This information includes step-by-step instructions for operating the meter from the current screen and possible applications information for that screen.

Touch **Delete** to delete a selected data point from the list. To delete a data point, first touch the data point you want to delete then touch the Delete button.

Touch **Delete All** to delete all the data point in the memory.

Touch **Print** to print all the data points in the memory.

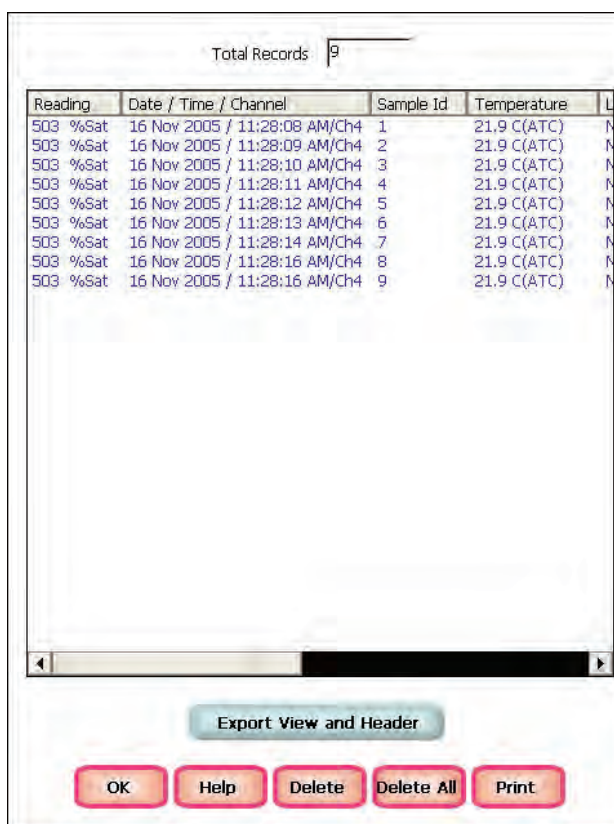

NOTE: Adjust column widths by touching the end of a column and dragging it to the desired width.

DO Setup: View Stored Data XL40 and 60 meters

Touch **Export View** and **Header (or Export View)** to save your data in HTML format. The file can be stored in the directory NAND Store, SD Card or USB thumb drive. After having selected the path, touch the alphanumeric keypad to name your file.

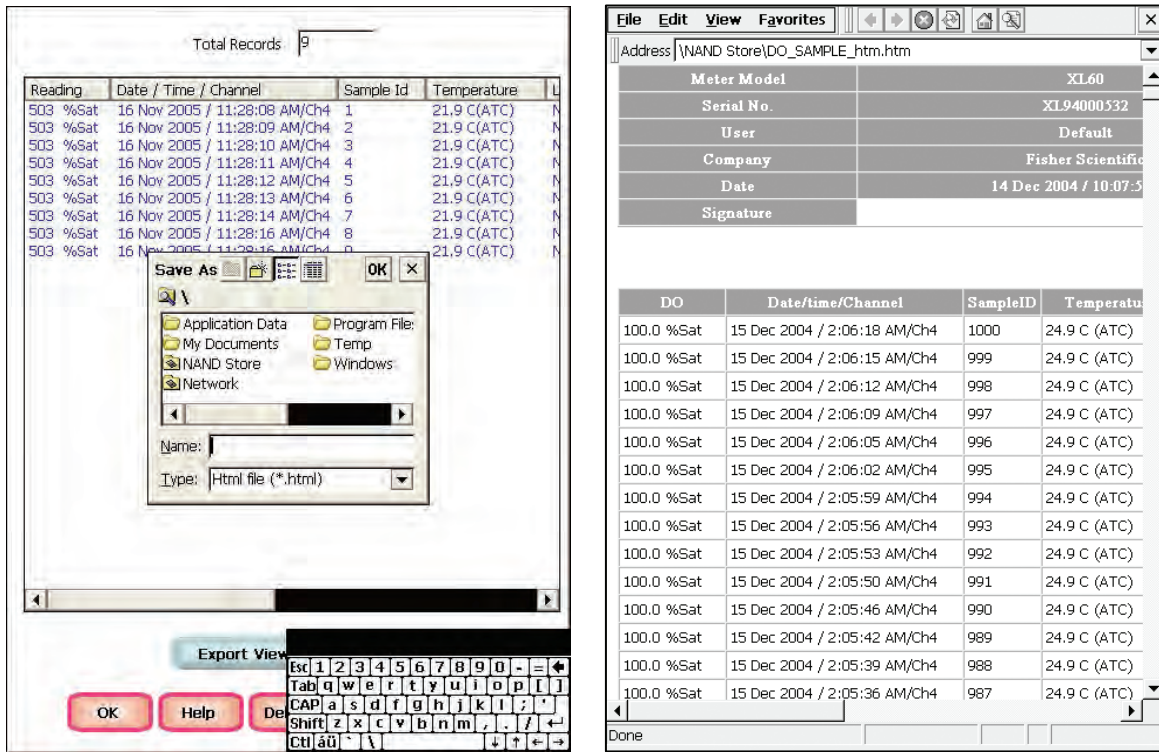

Touch the alphanumeric keypad to name your file.

Export view in HTML format

NOTE: If the file is stored in any location other than the three mentioned above, it will be lost when power is removed from the unit.

BOD Setup: BOD Setup Screen

XL40 and 60 meters

The BOD Setup screen present many options to control the operating parameters of the meter. The meter is factory set with regard to these options, and is ready for use under most circumstances (see '**Appendix: XL Series Meters Factory Default Settings**' section for default settings). The operating parameters of the BOD mode can be set and controlled from the BOD setup screen. The BOD setup screens are virtually identical to the DO setup screens with exceptions noted. The previous section on the DO Setup will guide you through the various options available in the BOD setup mode. The main difference is the BOD has a configuration to edit in the setup mode, see next page for details.

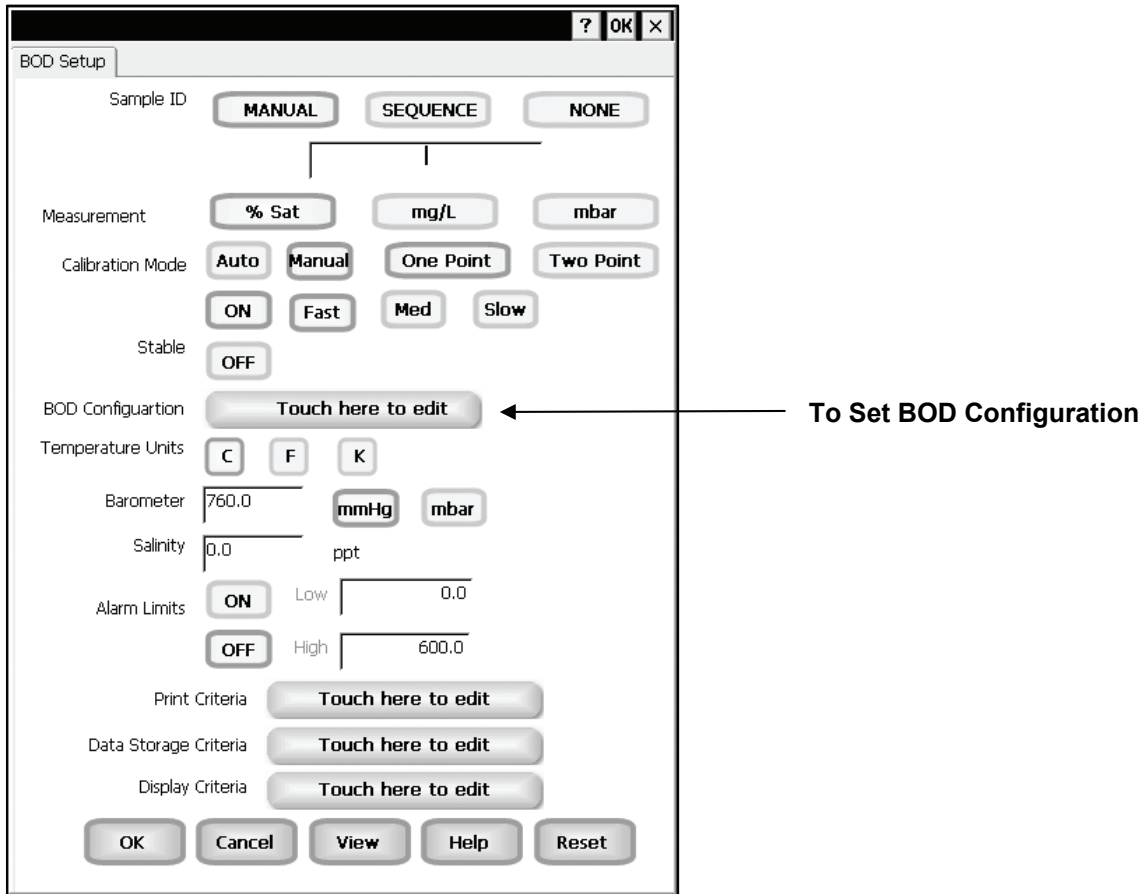

Example: - BOD Setup screen

Function Buttons on BOD Setup Screen

Touch **OK** to confirm BOD Setup and return to the BOD Measure screen.

Touch **Cancel** to exit and return to the BOD Measure screen without confirming BOD Setup.

Touch **View** will bring up Select View dialog box. You will have the option of selecting the BOD results or the all BOD data points stored in the memory.

When you touch the **Help** button, information about the current screen appears. This information includes step-by-step instructions for operating the meter from the current screen and possible applications information for that screen.

Touch **Reset** to reset all BOD Setup Criteria to the factory default.

BOD Setup: BOD Configuration

XL40 and 60 meters

This screen allows you configure the BOD seed minimum Delta DO, seed minimum DO endpoint, sample minimum Delta DO and sample minimum DO endpoint. You may set each from 0.0 to 60.0.

To set BOD Configuration

1. Touch the **Touch here to edit** button next to the BOD Configuration to access the BOD Configuration screen.
2. Touch the **Seed Min Delta D.O.** box and use the numeric keypad on the screen to enter desired value. The **BS** key allows you to remove characters that are incorrectly entered.
3. Touch **Enter** on the keypad to accept the value and return to the BOD Configuration screen.
4. Repeat steps **2** and **3** for the remaining boxes, Seed Min D.O. Endpoint, Sample Min Delta D.O. and Sample Min D.O Endpoint.
5. Touch **OK** button to accept the changes of the entire BOD configuration and return to the BOD Setup screen.

The screenshot shows the BOD Configuration screen. At the top, there is a header bar with 'BOD Configuration' on the left and a 'Touch here to edit' button on the right. Below this, the main screen is titled 'BOD Configuration'. It contains four input fields, each with a label on the left and a text box on the right. The labels and their corresponding values are: '-Seed Min Delta D.O.' with '2.0', '-Seed Min D.P. Endpoint' with '1.0', '-Sample Min Delta D.O.' with '2.0', and '-Sample Min D.O. Endpoint' with '1.0'. At the bottom of the screen, there are three buttons: 'OK', 'Cancel', and 'Help'.

The **Seed Minimum Delta DO** refers to the difference between the initial and final DO measurements for the seed used. If the delta is less than the minimum value entered, that BOD value will not be used to calculate seed values. The seed must exhibit a final DO value greater than the **Seed Minimum DO Endpoint** value entered. If not, it will not be used in computing seed values.

The **Sample Minimum Delta DO** refers to the difference between the initial and final value DO measurements of the sample. If the difference is less than the minimum value entered, that BOD value will not be used to calculate average BOD measurements. The sample must exhibit a final DO value greater than the **Sample Minimum DO Endpoint** value entered. If not, it will not be used in computing average BOD values.

OUR Setup: OUR Setup Screen

XL40 and 60 meters

The OUR Setup screen present many options to control the operating parameters of the meter. The meter is factory set with regard to these options, and is ready for use under most circumstances (see '**Appendix: XL Series Meters Factory Default Settings**' section for default settings). The operating parameters of the OUR mode can be set and controlled from the OUR setup screen. The OUR setup screens are virtually identical to the DO setup screens with exceptions noted. The previous section on the DO Setup will guide you through the various options available in the OUR setup mode. The main difference is the OUR has a configuration to edit in the setup mode, see next page for details.

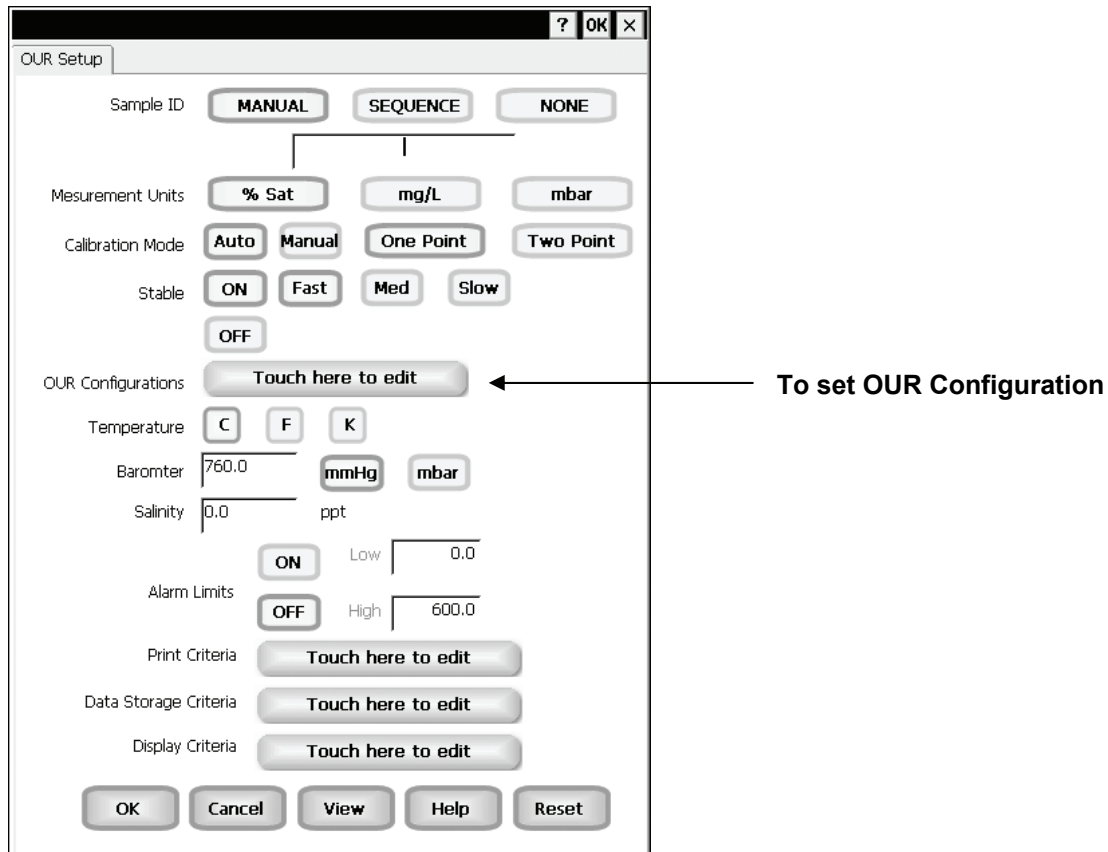

Example: - OUR Setup screen

Function Buttons on OUR Setup Screen

Touch **OK** to confirm OUR Setup and return to the OUR Measure screen.

Touch **Cancel** to exit and return to the OUR Measure screen without confirming OUR Setup.

Touch **View** will bring up Select View dialog box. You will have the option of selecting the OUR results or the all OUR data points stored in the memory.

When you touch the **Help** button, information about the current screen appears. This information includes step-by-step instructions for operating the meter from the current screen and possible applications information for that screen.

Touch **Reset** to reset all OUR Setup Criteria to the factory default.

OUR Setup: OUR Configuration

XL40 and 60 meters

This screen allows you configure the OUR dilution factor, minimum time in minutes for the test, maximum time in minutes for the test, minimum starting DO and minimum Ending DO. All values for these parameters are entered via a numeric keypad.

Dilution factor can be set from 1 to 25, if no dilution was required use a factor of 1. Minimum time should be less than the maximum time for the test (10 character limit for time in minutes). Minimum starting DO can be set from 5 to 60. Minimum ending DO can be set from 0 to 60.

To set OUR Configuration

1. Touch the **Touch here to edit** button next to the OUR Configuration to access the OUR Configuration screen.
2. Touch the **Dilution Factor (1 to X)** box and use the numeric keypad on the screen to enter desired value. The **BS** key allows you to remove characters that are incorrectly entered.
3. Touch **Enter** on the keypad to accept the value and return to the OUR Configuration screen.
4. Repeat steps **2** and **3** for the remaining boxes, Minimum Time (min), Maximum Time (min), Minimum Starting D.O. and Minimum Ending D.O.
5. Touch the **OK** button to accept the changes of the entire OUR configuration and return to the OUR Setup screen.

A screenshot of the "OUR Configuration" screen. The title "OUR Configuration" is centered at the top. Below the title are five rows, each with a label on the left and a numeric input field on the right. The labels and their corresponding values are: "Dilution Factor (1 to X)" with "1", "Minimum Time (min)" with "1", "Maximum Time (min)" with "1", "Minimum Starting D.O." with "5", and "Minimum Ending D.O." with "2". At the bottom of the screen are three buttons: "OK", "Cancel", and "Help", arranged horizontally from left to right.

SOUR Setup: SOUR Setup Screen

XL40 and 60 meters

The SOUR Setup screen present many options to control the operating parameters of the meter. The meter is factory set with regard to these options, and is ready for use under most circumstances (see '**Appendix: XL Series Meters Factory Default Settings**' section for default settings). The operating parameters of the SOUR mode can be set and controlled from the SOUR setup screen. The SOUR setup screens are virtually identical to the DO setup screens with exceptions noted. The previous section on the DO Setup will guide you through the various options available in the SOUR setup mode. The main difference is the SOUR has a configuration to edit in the setup mode, see next page for details.

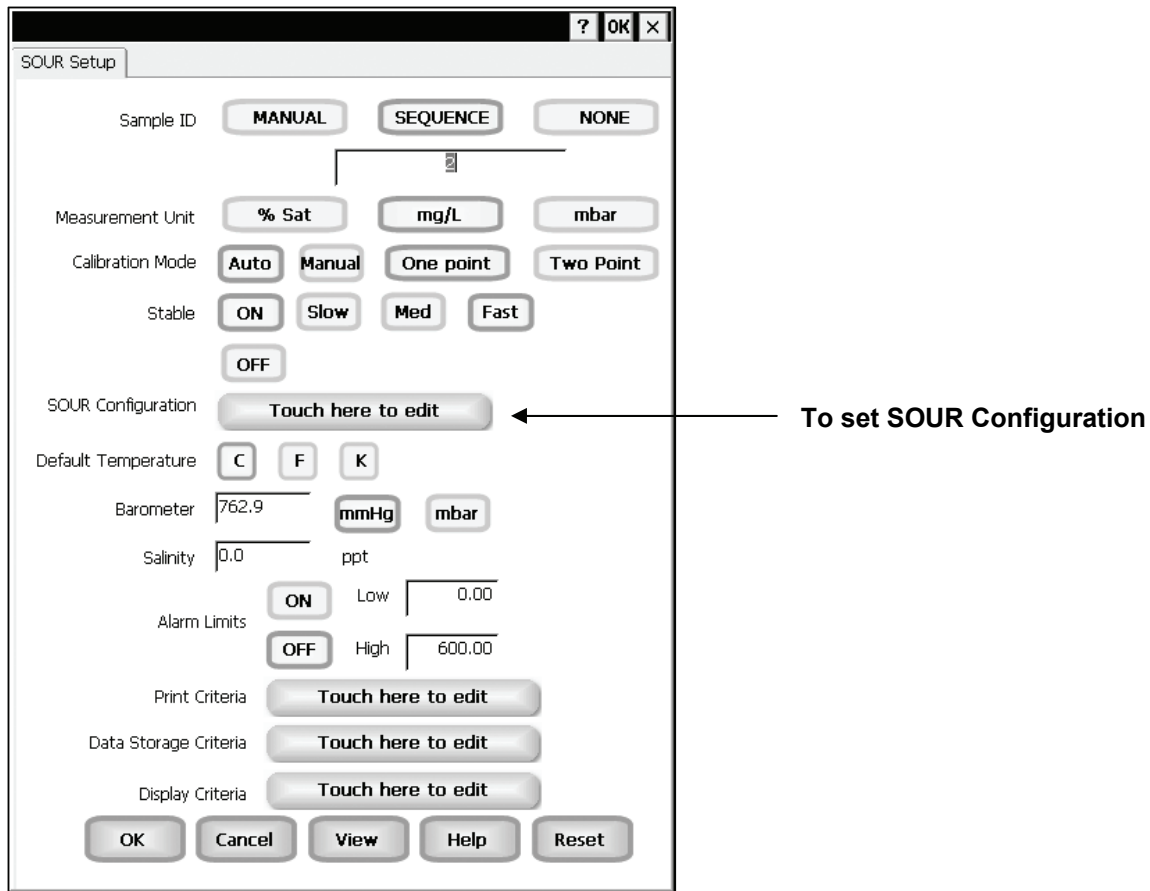

Example: - SOUR Setup screen

Function Buttons on SOUR Setup Screen

Touch **OK** to confirm SOUR Setup and return to the SOUR Measure screen.

Touch **Cancel** to exit and return to the SOUR Measure screen without confirming SOUR Setup.

Touch **View** will bring up Select View dialog box. You will have the option of selecting the SOUR results or the all SOUR data points stored in the memory.

When you touch the **Help** button, information about the current screen appears. This information includes step-by-step instructions for operating the meter from the current screen and possible applications information for that screen.

Touch **Reset** to reset all SOUR Setup Criteria to the factory default.

SOUR Setup: SOUR Configuration

XL40 and 60 meters

This screen allows you configure the SOUR dilution factor, minimum time in minutes for the test, maximum time in minutes for the test, minimum starting DO, minimum Ending DO and solids weight in grams per liter. All values for these parameters are entered via a numeric keypad.

Dilution factor can be set from 1 to 25, if no dilution was required use a factor of 1. Minimum time should be less than the maximum time for the test (10 character limit for time in minutes).

Minimum starting DO can be set from 5 to 60. Minimum ending DO can be set from 0 to 60.

To set SOUR Configuration

1. Touch the **Touch here to edit** button next to the SOUR Configuration to access the OUR Configuration screen.
2. Touch the **Dilution Factor (1 to X) box** and use the numeric keypad on the screen to enter desired value. The **BS** key allows you to remove characters that are incorrectly entered.
3. Touch **Enter** on the keypad to accept the value and return to the SOUR Configuration screen.
4. Repeat steps **2** and **3** for the remaining boxes, Minimum Time (min), Maximum Time (min), Minimum Starting D.O., Minimum Ending D.O. and Solids Weight (g/L).
5. Touch the **OK** button to accept the changes of the entire SOUR configuration and return to the SOUR Setup screen.

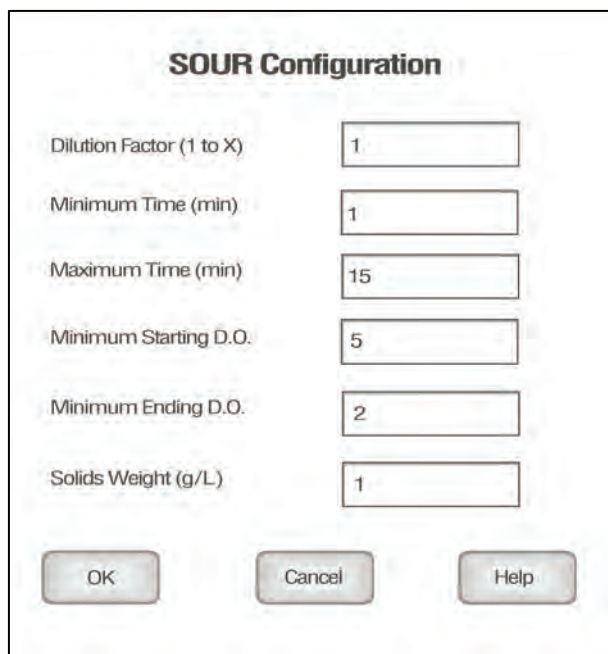

The "SOUR Configuration" screen displays six input fields with the following values:

Parameter	Value
Dilution Factor (1 to X)	1
Minimum Time (min)	1
Maximum Time (min)	15
Minimum Starting D.O.	5
Minimum Ending D.O.	2
Solids Weight (g/L)	1

At the bottom of the screen are three buttons: "OK", "Cancel", and "Help".

Conductivity Setup: Conductivity Setup Screen

XL20, 30, 50 and 60 meters

Available in XL20, XL30, XL50 and XL60, the conductivity Setup screen present many options to control the operating parameters of the meter. The meter is factory set with regard to these options, and is ready for use under most circumstances (see '**Appendix: XL Series Meters Factory Default Settings**' section for default settings). The operating parameters of the conductivity mode can be set and controlled from the conductivity setup screen. The conductivity Setup section will guide you through the various options available in the conductivity setup mode.

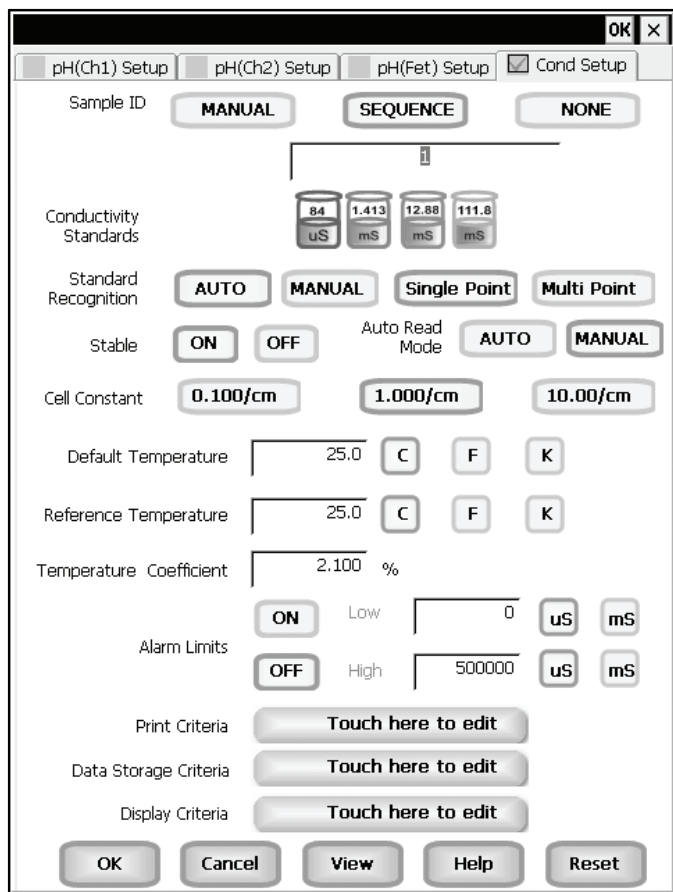

Example: - XL60 Conductivity Setup screen

Function Buttons on Conductivity Setup Screen

Touch **OK** to confirm conductivity Setup and return to the conductivity Measure screen.

Touch **Cancel** to exit and return to the conductivity Measure screen without confirming conductivity Setup.

Touch **View** to view all conductivity data points stored in memory. See '**Conductivity Setup: View Stored Data**' section for details.

When you touch the **Help** button, information about the current screen appears. This information includes step-by-step instructions for operating the meter from the current screen and possible applications information for that screen.

Touch **Reset** to reset all conductivity Setup Criteria to the factory default.

Conductivity Setup: Access Conductivity Setup

XL20, 30, 50 and 60 meters

To access the Setup screen:

1. Make sure you are in the conductivity Measure screen.
2. Touch the **Setup** button to access the conductivity Setup screen.

If you were in quadruple, triple or dual display mode, you have access to the Setup mode for each channel displayed. Touch the **Setup Channel** buttons at the top of the screen to toggle back and forth between the setup screens for each channel. To change Conductivity parameters, select the Conductivity Setup button.



If you were in single display mode, you will access the Setup mode for the single channel displayed only.



Conductivity Setup: Set Sample ID#

XL20, 30, 50 and 60 meters

A sample ID is required if you wish to log data or activate a timed printing. Whenever this option is active, each time you touch Log Data on the conductivity Measure screen, the conductivity value along with date/time/channel and the sample ID will be sent to data storage.

You can manually enter an alphanumeric identification number of 10 characters for any sample or you can have the meter sequentially number your samples beginning at the number of your choice. You can also choose to deactivate the sample ID.

To set sample ID — Manual:

1. Touch **Manual** for manual Sample ID entry.
2. The current ID is displayed on the screen.
3. Use the alphanumeric keypad on the screen to enter the desired Sample ID. The **BS** key will allow you to backspace to remove a character that was incorrectly entered.
4. Touch **Enter** to accept current Sample ID and return to the mV Setup screen.

To set sample ID — Sequential

1. Touch **Sequence** for sequential Sample ID entry
2. The current ID is displayed on the screen
3. Use the numeric keypad on the screen to enter the desired Sample ID number that you would like your sequential Sample ID assignment to begin with. Every time you touch **Print** or **Log Data** on the pH Measure screen, the Sample ID will increase by 1. The **BS** key will allow you to backspace to remove a character that was incorrectly entered.
4. Touch **Enter** to accept the first sequential Sample ID and return to the mV Setup screen.

To deactivate the sample ID assignment — None

1. Touch **None** to deactivate the sample ID assignment.

Sample ID

MANUAL SEQUENCE NONE

1000

Conductivity Setup: Conductivity Standards/Set Standard Recognition

Conductivity Standards

This setup option shows the set conductivity standards available for auto standard recognition. If Manual standard recognition is selected, the Conductivity Standards section will be blank.

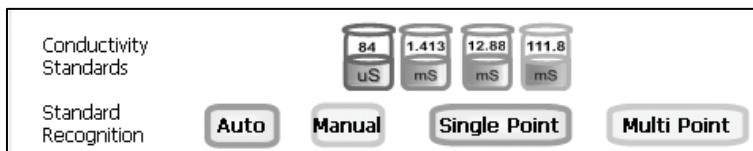

Conductivity Standards available with Auto Standard Recognition



Setup Screen with Manual Standard Recognition

Select Standard Recognition

This option allows you to select Automatic standard recognition or manual standard recognition when standardizing. With the automatic standard recognition activated, the meter will automatically recognize the buffers from the preset group (84 uS, 1.413 mS, 12.88 mS and 111.8 mS) and accept them when the meter recognizes the reading as stable.

When in the Manual standard recognition mode, you must enter the buffer value during the standardization procedure. The meter will accept the manually entered buffer once the measurement is stable.

This option also allows you to choose single-point or multi-point standardization. Use the single-point standardization option if you are measuring samples that close in value. Use the multi-point standardization option if you are measuring a wide range of samples. If a single point calibration is selected, there will be only one calibration factor for the entire range of operation. In the multi point mode, there will be one for each of the 4 ranges.

To select Standard Recognition

1. Touch **Auto** or **Manual** to choose the method of standard recognition.

To select Standardization Points

1. Touch **Single Point** or **Multi Point** to choose the method of standardization.



Conductivity Setup: Stable Indicator/Auto Read Mode/Cell Constant

XL20, 30, 50 and 60 meters

Select Stable Indicator

This setup option lets you turn **ON** or **OFF** the stability indicator. When this function is turned on, the **STABLE** indicator appears when the conductivity reading is stable.

To select Stable indicator

1. Touch **ON** or **OFF** to turn stable indicator on or off.



Select Auto Read Mode

You can use this meter when the Auto Read function is active or when it is inactive. When the Auto Read function is active, the meter will lock onto a reading when the meter recognizes it as stable. The meter will not deviate from this reading until Measure is touched. If the Auto Read function is inactive, then the meter will continuously monitor any resistivity fluctuations.

To select Auto Read Mode

1. Touch **MANUAL** or **AUTO** to choose the desired read mode.



Regardless of the status of the Auto Read Mode, **STABLE** will be displayed as the meter recognizes the measurement as stable.

Select Cell Constant

This setup option allows you to select the appropriate cell constant of the conductivity cell that you are using. There are three cell constants to choose from. Each is used for a different range of conductivity. The following indicates the optimal conductivity range for the accumet conductivity cells.

Optimal Conductivity Range

Cell Constant	2-cell	4-cell
0.1	0.5 to 200 μ S/cm	Not Available
1.0	0.01 to 2 mS/cm	0.01 to 20 mS/cm
10.0	1 to 200 mS/cm	1 to 200 mS/cm

Check the part number on your accumet[®] conductivity cell and compare to chart on the previous page to determine the cell constant of your conductivity cell.

To select Cell Constant

1. Touch **0.100/cm**, **1.000/cm**, or **10.00/cm** to choose the correct cell constant.



When you change cell constants your calibration factor will automatically reset to default values. It is recommended that you standardize your meter to establish a new calibration factor.

Conductivity Setup: Select Reference Temperature

XL20, 30, 50 and 60 meters

Set Default Temperature

Conductivity is a temperature dependent measurement. This option allows you to select a default temperature that the meter will use along with the temperature coefficient to calculate a temperature corrected conductivity measurement.

If an ATC probe is used any value entered as a default temperature will be overridden in favor of the actual measured temperature of the solution provided to the meter by the ATC probe.

The default temperature can be set from -10°C to 110°C.

To set Default Temperature

1. Select temperature units by touching the appropriate unit button: **C** (Celsius), **F** (Fahrenheit) or **K** (Kelvin).
2. Touch the **Default Temperature box** and use the numeric keypad to enter the desired default temperature (-10°C to 110°C).
3. Press **Enter** in the keypad to return to conductivity Setup screen.

Reference Temperature	25.0	C	F	K
-----------------------	------	---	---	---

accumet® conductivity cells for the XL60 have a built-in Temperature sensor.

Set Reference Temperature

This setup option allows you to select the reference temperature to be used in the determination of the conductivity of your sample. The reference temperature is the temperature to which the conductivity readings would be normalized.

The reference temperature can be set from 15°C to 30°C.

To set Reference Temperature

1. Select temperature units by touching the appropriate unit button: **C** (Celsius), **F** (Fahrenheit) or **K** (Kelvin).
2. Touch the **Reference Temperature box** and use the numeric keypad to enter the desired default temperature (15°C to 30°C).
3. Press **Enter** in the keypad to return to conductivity Setup screen.

Reference Temperature	25.0	C	F	K
-----------------------	------	---	---	---

Note: The units of all temperature parameters must match. The meter will automatically modify the temperature units of Default Temperature and Reference Temperature to match the last choice made on any of these parameters.

Conductivity Setup: Set Alarm Limits

XL20, 30, 50 and 60 meters

Set Temperature Coefficient

The temperature coefficient is a value that reflects the degree to which the sample's conductivity is effected by temperature changes. The meter will use the set temperature coefficient along with the measured temperature provided by the ATC probe to calculate what the conductivity would be at the selected reference temperature. If no ATC probe is being used, the meter will use the set default temperature in the calculation.

The temperature coefficient can be set from 0 to 10.000%.

To set Temperature Coefficient

1. Touch the **Temperature Coefficient box** and use the numeric keypad to enter the desired default temperature (0 to 10.000).
2. Press **Enter** in the keypad to return to conductivity Setup screen.

Temperature Coefficient	<input type="text" value="2.100"/>	%
-------------------------	------------------------------------	---

NOTE: The meter and probe with ATC will measure temperature even if the temperature coefficient is set to 0.0%, however a temperature correction will not be applied to the measurement.

Set Alarm Limits

This option allows you to set alarm limits for the conductivity measuring mode. If the conductivity value of the measurement is outside of the boundaries set by the minimum and maximum limits, audible and visual warnings will let you know that your sample measurement was outside of the set limits.

The Alarm Limit can be set from 0.0 uS to 500000.00 uS.

To set Alarm Limits

1. Touch **ON** or **OFF** to set the status of the alarm of conductivity mode
2. Touch the **Low box** and use numeric keypad to enter the new limit values.
3. Touch **Enter** on the keypad to accept this limit and return to the conductivity Setup screen.
4. Touch **uS** or **mS** to select conductivity units of low alarm value.
5. Touch the **High box** and use numeric keypad to enter the new limit values.
6. Touch **Enter** on the keypad to accept this limit and return to the conductivity Setup screen.
7. Touch **uS** or **mS** to select conductivity units of high alarm value.

Alarm Limits	<input type="button" value="ON"/>	Low	<input type="text" value="0"/>	<input type="button" value="uS"/>	<input type="button" value="mS"/>
	<input type="button" value="OFF"/>	High	<input type="text" value="500000"/>	<input type="button" value="uS"/>	<input type="button" value="mS"/>

Conductivity Setup: Set Print Criteria

XL20, 30, 50 and 60 meters

This screen allows you to select which criteria are printed with the measurement when you print the data or send it to a computer. The status of the current print criteria is displayed on the screen. The criteria option is active if **ON** appears to the right of the option. It is inactive if **OFF** appears to the right of the option. Any active criteria will be printed on demand.

To set Print Criteria

1. Touch the **Touch here to edit** button next to the Print Criteria to access the Conductivity Print Criteria Setup screen.
2. Touch **ON** or **OFF** to change the status of a criteria you want to modify.
3. Repeat step **2** for all the remaining criteria except Print Interval (*or Print Option*).
4. For Print Interval (*or Print Option*), select between **Log Data** and **Timed**. If “Log Data” is selected, clicking on the “Print” button from the Measurement screen will send the logged data to the printer. If “Timed” is selected, you can print data at an interval you select. This data is buffered and is sent to the printer when the page is full.
5. Touch **OK** button to accept the changes of the entire group of print criteria and return to the conductivity Setup screen.



Conductivity Print Criteria Setup

Date / Time / Channel	<input checked="" type="checkbox"/> ON	<input type="checkbox"/> OFF
Sample ID	<input checked="" type="checkbox"/> ON	<input type="checkbox"/> OFF
Cell Constant	<input checked="" type="checkbox"/> ON	<input type="checkbox"/> OFF
Temperature	<input checked="" type="checkbox"/> ON	<input type="checkbox"/> OFF
Reference Temperature.	<input checked="" type="checkbox"/> ON	<input type="checkbox"/> OFF
Temperature Coefficient.	<input checked="" type="checkbox"/> ON	<input type="checkbox"/> OFF
Last Standardization	<input checked="" type="checkbox"/> ON	<input type="checkbox"/> OFF
Meter Model/Serial No	<input checked="" type="checkbox"/> ON	<input type="checkbox"/> OFF
Operator	<input checked="" type="checkbox"/> ON	<input type="checkbox"/> OFF
Print Interval	<input checked="" type="checkbox"/> LOG DATA	<input type="checkbox"/> TIMED

Conductivity Setup: Data Storage Criteria

XL20, 30, 50 and 60 meters

This screen allows you to select which criteria are stored in the data logger with the measurement when you store the data. The status of the current data storage criteria is displayed on the screen. The criteria option is active if **ON** appears to the right of the option. It is inactive if **OFF** appears to the right of the option. Any active criteria will be stored on demand.

To set Data Storage Criteria

1. Touch the Touch here to edit button next to the Data Storage Criteria to access the Conductivity Data Storage Criteria Setup screen.
2. Touch **ON** or **OFF** to change the status of a criteria you want to modify.
3. Repeat step 2 for all the remaining criteria except Data logging Interval (*Data storage Interval*).
4. For Data logging Interval (*Data storage Interval*), touch **MANUAL** to log conductivity data only when the Log Data button is pushed, touch **STABLE** to automatically log conductivity data when conductivity reading is stable, or touch **TIMED** to set a specific timed interval in seconds to log conductivity data.
5. Touch **OK** button to accept the changes of the entire group of data storage criteria and return to the conductivity Setup screen.

Data Storage Criteria

Touch here to edit

Conductivity Data Storage Criteria Setup

Date / Time / Channel	<input type="button" value="ON"/>	<input type="button" value="OFF"/>	
Sample ID	<input type="button" value="ON"/>	<input type="button" value="OFF"/>	
Cell Constant	<input type="button" value="ON"/>	<input type="button" value="OFF"/>	
Temperature	<input type="button" value="ON"/>	<input type="button" value="OFF"/>	
Reference Temperature	<input type="button" value="ON"/>	<input type="button" value="OFF"/>	
Temperature Coefficient	<input type="button" value="ON"/>	<input type="button" value="OFF"/>	
Last Standardization	<input type="button" value="ON"/>	<input type="button" value="OFF"/>	
Meter Model/Serial No	<input type="button" value="ON"/>	<input type="button" value="OFF"/>	
Operator	<input type="button" value="ON"/>	<input type="button" value="OFF"/>	
Data logging Interval	<input type="button" value="MANUAL"/>	<input type="button" value="STABLE"/>	<input type="button" value="TIMED"/>
	<input type="button" value="OK"/>	<input type="button" value="Cancel"/>	<input type="button" value="Help"/>

Conductivity Setup: Set Display Criteria

XL20, 30, 50 and 60 meters

This screen allows you to choose what information you would like to be displayed on the conductivity Measure screen, particularly the information contained in the data box at the bottom of the Measurement screen. The status of the current display criteria is displayed on the screen. The criteria option is active if **ON** appears to the right of the option. It is inactive if **OFF** appears to the right of the option.

To set Display Criteria

1. Touch the **Touch here to edit button** next to the Display Criteria to access the Conductivity Display Criteria Setup screen.
2. Touch **ON** or **OFF** to change the status of a criteria you want to modify.
3. Repeat step 2 for all the remaining criteria.
4. Touch the **OK** button to accept the changes of the entire group of display criteria and return to the conductivity Setup screen.

Display Criteria

Touch here to edit

Conductivity Display Criteria Setup

Measurement Channel	<input type="button" value="ON"/>	<input type="button" value="OFF"/>
Last Standardized Detail	<input type="button" value="ON"/>	<input type="button" value="OFF"/>
Sample ID	<input type="button" value="ON"/>	<input type="button" value="OFF"/>
Cell Constant	<input type="button" value="ON"/>	<input type="button" value="OFF"/>
Cell Type	<input type="button" value="ON"/>	<input type="button" value="OFF"/>
Temperature	<input type="button" value="ON"/>	<input type="button" value="OFF"/>
Reference Temperature	<input type="button" value="ON"/>	<input type="button" value="OFF"/>
Temperature Coefficient	<input type="button" value="ON"/>	<input type="button" value="OFF"/>
Range	<input type="button" value="ON"/>	<input type="button" value="OFF"/>
Auto Read Status	<input type="button" value="ON"/>	<input type="button" value="OFF"/>
Standardization Factor	<input type="button" value="ON"/>	<input type="button" value="OFF"/>
Standardization Points	<input type="button" value="ON"/>	<input type="button" value="OFF"/>
Standard Recognition	<input type="button" value="ON"/>	<input type="button" value="OFF"/>

OK

Cancel

Help

Conductivity Setup: View Stored Data

XL20, 30, 50 and 60 meters

The XL20, XL30, XL50 and XL60 have a memory capacity to store up to 1000 data points. The View Stored Data screen allows you to sort and look at specific data points stored in the meter based on the meters memory capacity. The stored data can be sorted by any of the parameters available in the screen header.

The meter stores conductivity data under the following parameters:

Reading	Temperature Coefficient
Date / Time / Channel	Cell Type
Sample Id	Last Standardizations
Temperature	Meter Model / Serial No
Reference Temperature	Operator

To View Stored Data

1. Touch the View button in the conductivity Setup screen.



You can only log 1000 data points at a time. To clear space for new data points, you have to delete the same number of old data points as you want to add new data points.

Function buttons on View Stored Data Screen

Touch **OK** to go back to the Conductivity Setup screen from the View Stored Data screen.

When you touch the **Help** button, information about the current screen appears. This information includes step-by-step instructions for operating the meter from the current screen and possible applications information for that screen.

Touch **Delete** to delete a selected data point from the list. To delete a data point, first touch the data point you want to delete then touch the Delete button.

Touch **Delete All** to delete all the data point in the memory.

Touch **Print** to print all the data points in the memory.

See next page for **Export View and Header (or Export View)** explanation.



Total Records: 9

Reading	Date / Time / Channel	Sample Id	Temperature	Re
100.1 uS/cm	16 Nov 2005 / 11:31:50 AM/Ch5	9	25.0 C(Default)	23
100.1 uS/cm	16 Nov 2005 / 11:31:49 AM/Ch5	8	25.0 C(Default)	23
100.1 uS/cm	16 Nov 2005 / 11:31:48 AM/Ch5	7	25.0 C(Default)	23
100.1 uS/cm	16 Nov 2005 / 11:31:47 AM/Ch5	6	25.0 C(Default)	23
100.1 uS/cm	16 Nov 2005 / 11:31:46 AM/Ch5	5	25.0 C(Default)	23
100.1 uS/cm	16 Nov 2005 / 11:31:45 AM/Ch5	4	25.0 C(Default)	23
100.1 uS/cm	16 Nov 2005 / 11:31:44 AM/Ch5	3	25.0 C(Default)	23
100.1 uS/cm	16 Nov 2005 / 11:31:43 AM/Ch5	2	25.0 C(Default)	23
100.1 uS/cm	16 Nov 2005 / 11:31:41 AM/Ch5	1	25.0 C(Default)	23

Export View and Header

OK Help Delete Delete All Print

Conductivity Setup: View Stored Data

XL20, 30, 50 and 60 meters

Touch **Export View** and **Header (or Export View)** to save your data in HTML format. The file can be stored in either the Nand flash, SD Card or any of the other available locations as shown in the window. After having selected the path, touch the alphanumeric keypad to name your file.

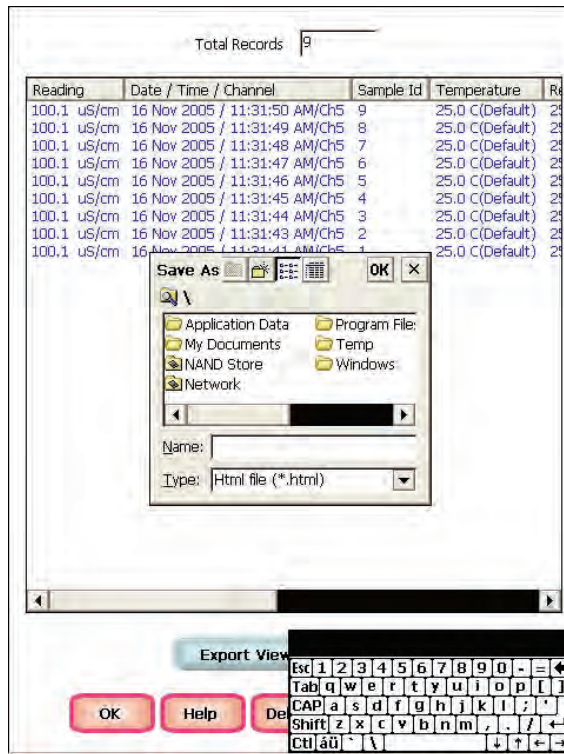

Touch the alphanumeric keypad to name your file.

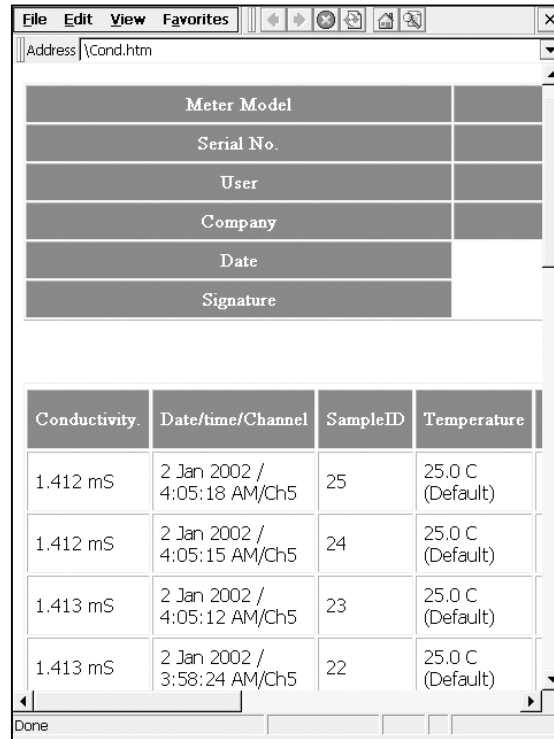

Export view in HTML format

Resistivity Setup: Resistivity Setup Screen

XL20, 30, 50 and 60 meters

Available in XL20, XL30, XL50 and XL60 meters, the resistivity Setup screen present many options to control the operating parameters of the meter. The meter is factory set with regard to these options, and is ready for use under most circumstances (see '**Appendix: XL Series Meters Factory Default Settings**' section for default settings). The operating parameters of the resistivity mode can be set and controlled from the resistivity setup screen. The resistivity Setup section will guide you through the various options available in the resistivity setup mode.

The screenshot shows the Resistivity Setup screen with the following settings:

- Sample ID: MANUAL
- Calibration Point: Single Point
- Stable: ON
- Auto Read Mode: AUTO
- Cell Constant: 1.000/cm
- Default Temperature: 25.0 C
- Reference Temperature: 25.0 C
- Temperature Coefficient: 2.100 %
- Alarm Limits: ON Low 3.000 Ohm, OFF High 100.000 Ohm
- Print Criteria: Touch here to edit
- Data Storage Criteria: Touch here to edit
- Display Criteria: Touch here to edit

Example: - XL60 Resistivity Setup screen

Function Buttons on Resistivity Setup Screen

Touch **OK** to confirm resistivity Setup and return to the resistivity Measure screen.

Touch **Cancel** to exit and return to the resistivity Measure screen without confirming resistivity Setup.

Touch **View** to view all resistivity data points stored in memory. See '**Resistivity Setup: View Stored Data**' section for details.

When you touch the **Help** button, information about the current screen appears. This information includes step-by-step instructions for operating the meter from the current screen and possible applications information for that screen.

Touch **Reset** to reset all resistivity Setup Criteria to the factory default.

Resistivity Setup: Access Resistivity Setup

XL20, 30, 50 and 60 meters

To access the Setup screen:

1. Make sure you are in the resistivity Measure screen.
2. Touch the Setup button to access the resistivity Setup screen.

If you were in quadruple, triple or dual display mode, you have access to the Setup mode for each channel displayed. Touch the **Setup Channel** buttons at the top of the screen to toggle back and forth between the setup screens for each channel. To change Resistivity parameters, select the Resistivity Setup button.



If you were in single display mode, you will access the Setup mode for the single channel displayed only.



Resistivity Setup

XL20, 30, 50 and 60 meters

To Set Sample ID#

A sample ID is required if you wish to log data or activate a timed printing. Whenever this option is active, each time you touch **Log Data** on the resistivity Measure screen, the resistivity value along with date/time/channel and the sample ID will be sent to data storage.

You can manually enter an alphanumeric identification number of 10 characters for any sample or you can have the meter sequentially number your samples beginning at the number of your choice. You can also choose to deactivate the sample ID.

The resistivity Sample ID# is set the same way as previously described in Conductivity Setup. See '**Conductivity Setup: Set Sample ID#**' section for instructions.

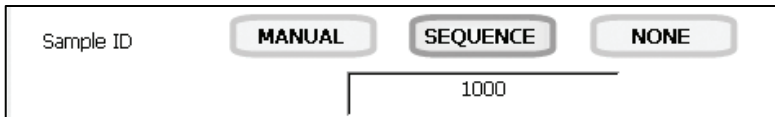

To Set Calibration Point(s)

This option also allows you to choose single-point or multi-point standardization. Use the single-point standardization option if you are measuring samples that close in value. Use the multi-point standardization option if you are measuring a wide range of samples. If a single point calibration is selected, there will be only one calibration factor for the entire range of operation. In the multi point mode, there will be one for each of the 4 ranges.

To select Calibration Point(s)

1. Touch **Single Point** or **Multi Point** to choose the method of standardization.



To Select Stable Indicator

This setup option lets you turn **ON** or **OFF** the stability indicator. When this function is turned on, the STABLE appears when the resistivity reading is stable.

To select Stable indicator

1. Touch **ON** or **OFF** to turn stable indicator on or off.

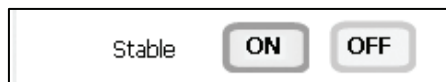

To Select Auto Read Mode

You can use this meter when the Auto Read function is active or when it is inactive. When the Auto Read function is active, the meter will lock onto a reading when the meter recognizes it as stable. The meter will not deviate from this reading until Measure is touched. If the Auto Read function is inactive, then the meter will continuously monitor any resistivity fluctuations.

To select Auto Read Mode

1. Touch **MANUAL** or **AUTO** to choose the desired read mode



Resistivity Setup

XL20, 30, 50 and 60 meters

To Select Cell Constant

This setup option allows you to select the appropriate cell constant of the cell that you are using. There are three cell constants to choose from. Each is used for a different range of resistivity.

The Resistivity Cell Constant is set the same way as previously described in Conductivity Setup. See '**Conductivity Setup: Stable Indicator/Auto Read Mode/Cell Constant**' section for instructions.

Cell Constant 0.100 / cm 1.000 / cm 10.00 / cm

When you change cell constants your calibration factor will automatically reset to default values. It is recommended that you standardize your meter to establish a new calibration factor.

To Set Default Temperature

Resistivity is a temperature dependent measurement. This option allows you to select a default temperature that the meter will use along with the temperature coefficient to calculate a temperature corrected resistivity measurement. If an ATC probe is used, any value entered as a default temperature will be overridden in favor of the actual measured temperature of the solution the ATC probe provides to the meter. The default temperature can be set from -10°C to 110°C.

The Resistivity Default Temperature is set the same way as previously described in Conductivity Setup. See '**Conductivity Setup: Select Reference Temperature**' section for instructions.

Default Temperature C F K

To Set Reference Temperature

This setup option lets you select the reference temperature to be used in the determination of the resistivity of your sample. The reference temperature is the temperature to which the resistivity readings would be normalized. The reference temperature can be set from 15°C to 30°C.

The Resistivity Reference Temperature is set the same way as previously described in Conductivity Setup. See '**Conductivity Setup: Select Reference Temperature**' section for instructions.

Reference Temperature C F K

To Set Temperature Coefficient

The temperature coefficient is a value that reflects the degree to which the sample's resistivity is effected by temperature changes. The meter will use the set temperature coefficient along with the measured temperature provided by the ATC probe to calculate what the resistivity would be at the selected reference temperature. If no ATC probe is being used, the meter will use the set default temperature in the calculation. The temperature coefficient can be set from 0 to 10.000%.

The Resistivity Temperature Coefficient is set the same way as previously described in section '**Conductivity Setup: Set Alarm Limits**'.

Temperature Coefficient %

NOTE: The meter and probe with ATC will measure temperature even if the temperature coefficient is set to 0.0%, however a temperature correction will not be applied to the measurement.

Resistivity Setup

XL20, 30, 50 and 60 meters

To Set Alarm Limits

This option allows you to set alarm limits for the resistivity measuring mode. If the resistivity value of the measurement is outside of the boundaries set by the minimum and maximum limits, audible and visual warnings will let you know that your sample measurement was outside of the set limits.

The Alarm Limit can be set from 3.000 Ohm to 100.000 M Ohm.

To set Alarm Limits

1. Touch **ON** or **OFF** to set the status of the alarm of resistivity mode
2. Touch the **Low box** and use numeric keypad to enter the new limit values.
3. Touch **Enter** on the keypad to accept this limit and return to the resistivity Setup screen.
4. Touch **Ohm, KOhm** or **MOhm** to select resistivity units of low alarm value.
5. Touch the **High box** and use numeric keypad to enter the new limit values.
6. Touch **Enter** on the keypad to accept this limit and return to the resistivity Setup screen.
7. Touch **Ohm, KOhm** or **MOhm** to select resistivity units of high alarm value.

Alarm Limits	<input type="button" value="ON"/>	Low	3.000	<input type="button" value="Ohm"/>	<input type="button" value="KOhm"/>	<input type="button" value="MOhm"/>
	<input type="button" value="OFF"/>	High	100.000	<input type="button" value="Ohm"/>	<input type="button" value="KOhm"/>	<input type="button" value="MOhm"/>

To Set Print Criteria

This screen allows you to select which criteria are printed with the measurement when you print the data or send it to a computer. The status of the current print criteria is displayed on the screen. The criteria option is active if ON appears to the right of the option. It is inactive if OFF appears to the right of the option. Any active criteria will be printed on demand.

The Resistivity Print Criteria is set the same way as previously described in Conductivity Setup. See '**Conductivity Setup: Set Print Criteria**' section for instructions.

Print Criteria	<input type="button" value="Touch here to edit"/>
----------------	---

Resistivity Setup

XL20, 30, 50 and 60 meters

To Set Data Storage Criteria

This screen allows you to select which criteria are stored in the data logger with the measurement when you store the data. The status of the current data storage criteria is displayed on the screen. The criteria option is active if ON appears to the right of the option. It is inactive if OFF appears to the right of the option. Any active criteria will be stored on demand.

The Resistivity Data Storage Criteria is set the same way as previously described in Conductivity Setup. See '**Conductivity Setup: Data Storage Criteria**' section for instructions.



To Set Display Criteria

This screen allows you to choose what information you would like to be displayed on the resistivity Measure screen, particularly the information contained in the data box at the bottom of the Measurement screen. The status of the current display criteria is displayed on the screen. The criteria option is active if ON appears to the right of the option. It is inactive if OFF appears to the right of the option.

The Resistivity Display Criteria is set the same way as previously described in Conductivity Setup. See '**Conductivity Setup: Set Display Criteria**' section for instructions.



To View Stored Data

The XL20, XL30, XL50 and XL60 have a memory capacity to store up to 1000 data points. The View Stored Data screen allows you to sort and look at specific data points stored in the meter based on the meters memory capacity. The stored data can be sorted by any of the parameters available in the screen header.

The meter stores resistivity data under the following parameters:

Reading	Temperature Coefficient
Date / Time / Channel	Cell Type
Sample Id	Last Standardizations
Temperature	Meter Model / Serial No
Reference Temperature	Operator

Viewing Stored Resistivity Data is done the same way as previously described in Conductivity Setup. See '**Conductivity Setup: View Stored Data**' section for instructions.



TDS Setup: TDS Setup Screen

XL20, 30, 50 and 60 meters

Available in XL20, XL30, XL50 and XL60 meters, the TDS Setup screen present many options to control the operating parameters of the meter. The meter is factory set with regard to these options, and is ready for use under most circumstances (see '**Appendix: XL Series Meters Factory Default Settings**' section for default settings). The operating parameters of the TDS mode can be set and controlled from the TDS setup screen. The TDS Setup section will guide you through the various options available in the TDS setup mode.

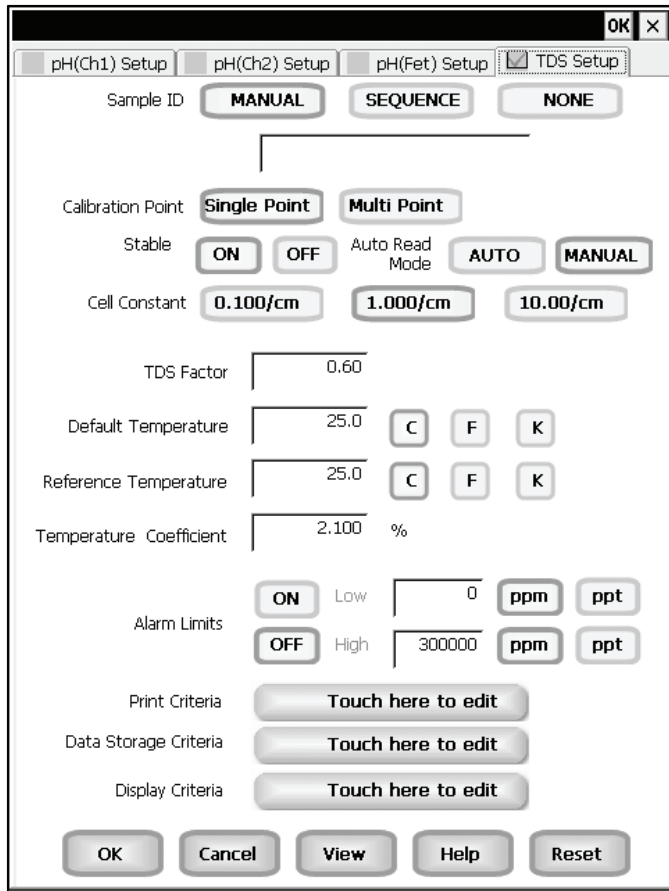

Example: - XL60 TDS Setup screen

Function Buttons on TDS Setup Screen

Touch **OK** to confirm TDS Setup and return to the TDS Measure screen.

Touch **Cancel** to exit and return to the TDS Measure screen without confirming TDS Setup.

Touch **View** to view all TDS data points stored in memory. See '**TDS Setup: View Stored Data**' section for details.

When you touch the **Help** button, information about the current screen appears. This information includes step-by-step instructions for operating the meter from the current screen and possible applications information for that screen.

Touch **Reset** to reset all TDS Setup Criteria to the factory default.

TDS Setup: Access TDS Setup

XL20, 30, 50 and 60 meters

To access the Setup screen:

1. Make sure you are in the TDS Measure screen.
2. Touch the Setup button to access the TDS Setup screen.

If you were in quadruple, triple or dual display mode, you have access to the Setup mode for each channel displayed. Touch the **Setup Channel** buttons at the top of the screen to toggle back and forth between the setup screens for each channel. To change TDS parameters, select the TDS Setup button.



If you were in single display mode, you will access the Setup mode for the single channel displayed only.



TDS Setup

XL20, 30, 50 and 60 meters

To Set Sample ID#

A sample ID is required if you wish to log data or activate a timed printing. Whenever this option is active, each time you touch Log Data on the TDS Measure screen, the TDS value along with date/time/channel and the sample ID will be sent to data storage.

You can manually enter an alphanumeric identification number of 10 characters for any sample or you can have the meter sequentially number your samples beginning at the number of your choice. You can also choose to deactivate the sample ID.

The TDS Sample ID# is set the same way as previously described in Conductivity Setup. See **'Conductivity Setup: Set Sample ID#'** section for instructions.

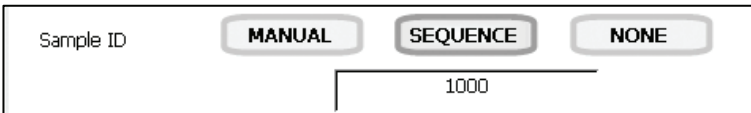

To Set Calibration Point(s)

This option also allows you to choose single-point or multi-point standardization.

Use the single-point standardization option if you are measuring samples that close in value. Use the multi-point standardization option if you are measuring a wide range of samples. If a single point calibration is selected, there will be only one calibration factor for the entire range of operation. In the multi point mode, there will be one for each of the 4 ranges.

To select Calibration Point(s)

1. Touch **Single Point** or **Multi Point** to choose the method of standardization.



To Select Stable Indicator

This setup option lets you turn ON or OFF the stability indicator. When this function is turned on, the STABLE appears when the TDS reading is stable.

To select Stable indicator

1. Touch **ON** or **OFF** to turn stable indicator on or off.

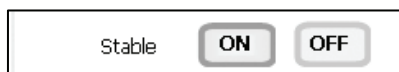

To Select Auto Read Mode

You can use this meter when the Auto Read function is active or when it is inactive. When the Auto Read function is active, the meter will lock onto a reading when the meter recognizes it as stable. The meter will not deviate from this reading until Measure is touched. If the Auto Read function is inactive, then the meter will continuously monitor any TDS fluctuations.

To select Auto Read Mode

1. Touch **MANUAL** or **AUTO** to choose the desired read mode.



TDS Setup

XL20, 30, 50 and 60 meters

To Select Cell Constant

This setup option allows you to select the appropriate cell constant of the cell that you are using. There are three cell constants to choose from. Each is used for a different range of TDS.

The TDS Cell Constant is set the same way as previously described in Conductivity Setup. See '**Conductivity Setup: Stable Indicator/Auto Read Mode/Cell Constant**' section for instructions.

Cell Constant	0.100 / cm	1.000 / cm	10.00 / cm
---------------	------------	------------	------------

When you change cell constants your calibration factor will automatically reset to default values. It is recommended that you standardize your meter to establish a new calibration factor.

To Set TDS Factor

A TDS conversion factor is needed when a solution does not have a similar ionic content to natural water or salt water. The TDS conversion factor automatically adjusts the reading.

The TDS conversion factor can be set from 0.40 to 1.00.

To set TDS Factor

1. Touch the **TDS Factor box** and use the numeric keypad to enter the desired default temperature (0.40 to 1.00).
2. Press **Enter** in the keypad to return to TDS Setup screen.

TDS Factor	0.60
------------	------

To Set Default Temperature

TDS is a temperature dependent measurement. This option allows you to select a default temperature that the meter will use along with the temperature coefficient to calculate a temperature corrected TDS measurement. If an ATC probe is used any value entered as a default temperature will be overridden in favor of the actual measured temperature of the solution provided to the meter by the ATC probe.

The default temperature can be set from -10°C to 110°C.

The TDS Default Temperature is set the same way as previously described in Conductivity Setup. See '**Conductivity Setup: Select Reference Temperature**' section for instructions.

Default Temperature	25.0	C	F	K
---------------------	------	---	---	---

To Set Reference Temperature

This setup option allows you to select the reference temperature to be used in the determination of the TDS of your sample. The reference temperature is the temperature to which the TDS readings would be normalized.

The reference temperature can be set from 15°C to 30°C.

The TDS Reference Temperature is set the same way as previously described in Conductivity Setup. See '**Conductivity Setup: Select Reference Temperature**' section for instructions.

Reference Temperature	25.0	C	F	K
-----------------------	------	---	---	---

TDS Setup

XL20, 30, 50 and 60 meters

To Set Temperature Coefficient

The temperature coefficient is a value that reflects the degree to which the sample's TDS is affected by temperature changes. The meter will use the set temperature coefficient along with the measured temperature provided by the ATC probe to calculate what the TDS would be at the selected reference temperature. If no ATC probe is being used, the meter will use the set default temperature in the calculation.

The temperature coefficient can be set from 0 to 10.000%.

The TDS Temperature Coefficient is set the same way as previously described in '**Conductivity Setup: Set Alarm Limits**' section.

NOTE: The meter and probe with ATC will measure temperature even if the temperature coefficient is set to 0.0%, however a temperature correction will not be applied to the measurement.

Temperature Coefficient	2.100	%
-------------------------	-------	---

To Set Alarm Limits

This option allows you to set alarm limits for the TDS measuring mode. If the TDS value of the measurement is outside of the boundaries set by the minimum and maximum limits, audible and visual warnings will let you know that your sample measurement was outside of the set limits.

The Alarm Limit can be set from 0.00 to 500.00 ppt (depending upon TDS factor).

To set Alarm Limits

1. Touch **ON** or **OFF** to set the status of the alarm of TDS mode
2. Touch the **Low box** and use numeric keypad to enter the new limit values.
3. Touch **Enter** on the keypad to accept this limit and return to the TDS Setup screen.
4. Touch **PPM** or **PPT** to select TDS units of low alarm value.
5. Touch the **High box** and use numeric keypad to enter the new limit values.
6. Touch **Enter** on the keypad to accept this limit and return to the TDS Setup screen.
7. Touch **PPM** or **PPT** to select TDS units of high alarm value.

Alarm Limits	ON	Low	0	ppm	ppt
	OFF	High	300000	ppm	ppt

To Set Print Criteria

This screen allows you to select which criteria are printed with the measurement when you print the data or send it to a computer. The status of the current print criteria is displayed on the screen. The criteria option is active if **ON** appears to the right of the option. It is inactive if **OFF** appears to the right of the option. Any active criteria will be printed on demand.

The TDS Print Criteria is set the same way as previously described in Conductivity Setup. See '**Conductivity Setup: Set Print Criteria**' section for instructions.

Print Criteria	Touch here to edit
----------------	---------------------------

TDS Setup

XL20, 30, 50 and 60 meters

To Set Data Storage Criteria

This screen allows you to select which criteria are stored in the data logger with the measurement when you store the data. The status of the current data storage criteria is displayed on the screen. The criteria option is active if **ON** appears to the right of the option. It is inactive if **OFF** appears to the right of the option. Any active criteria will be stored on demand.

The TDS Data Storage Criteria is set the same way as previously described in Conductivity Setup. See '**Conductivity Setup: Data Storage Criteria**' section for instructions.



To Set Display Criteria

This screen allows you to choose what information you would like to be displayed on the TDS Measure screen, particularly the information contained in the data box at the bottom of the Measurement screen. The status of the current display criteria is displayed on the screen. The criteria option is active if **ON** appears to the right of the option. It is inactive if **OFF** appears to the right of the option.

The TDS Display Criteria is set the same way as previously described in Conductivity Setup. See '**Conductivity Setup: Set Display Criteria**' section for instructions.



To View Stored Data

The XL20, XL30, XL50 and XL60 have a memory capacity to store up to 1000 data points. The View Stored Data screen allows you to sort and look at specific data points stored in the meter based on the meters memory capacity. The stored data can be sorted by any of the parameters available in the screen header.

The meter stores TDS data under the following parameters:

Reading	Temperature Coefficient
Date / Time / Channel	Cell Type
Sample Id	Last Standardizations
Temperature	Meter Model / Serial No
Reference Temperature	Operator

Viewing Stored TDS Data is done the same way as previously described in Conductivity Setup. See '**Conductivity Setup: View Stored Data**' section for instructions.



Salinity Setup: Salinity Setup Screen

XL20, 30, 50 and 60 meters

Available in the XL20, XL30, XL50 and XL60 meters, the salinity Setup screen present many options to control the operating parameters of the meter. The meter is factory set with regard to these options, and is ready for use under most circumstances (see '**Appendix: XL Series Meters Factory Default Settings**' section for default settings). The operating parameters of the salinity mode can be set and controlled from the salinity setup screen. The salinity Setup section will guide you through the various options available in the salinity setup mode.

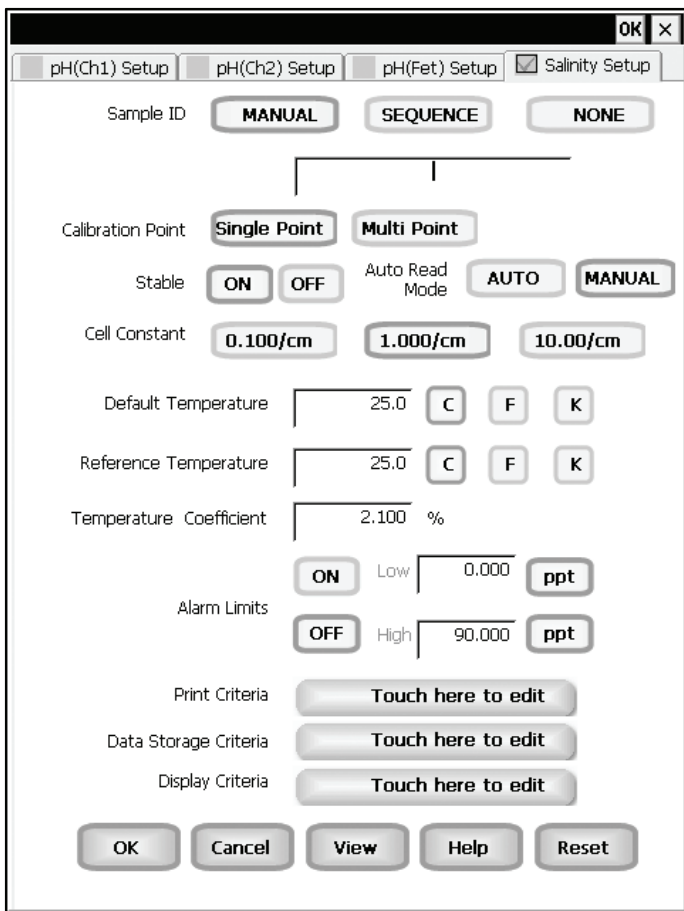

Example: - XL60 Salinity Setup screen

Function Buttons on Salinity Setup Screen

Touch **OK** to confirm salinity Setup and return to the salinity Measure screen.

Touch **Cancel** to exit and return to the salinity Measure screen without confirming salinity Setup.

Touch **View** to view all salinity data points stored in memory. See '**Salinity Setup: View Stored Data**' section for details.

When you touch the **Help** button, information about the current screen appears. This information includes step-by-step instructions for operating the meter from the current screen and possible applications information for that screen.

Touch **Reset** to reset all salinity Setup Criteria to the factory default.

Salinity Setup: Access Salinity Setup

XL20, 30, 50 and 60 meters

To access the Setup screen:

1. Make sure you are in the salinity Measure screen.
2. Touch the Setup button to access the salinity Setup screen.

If you were in quadruple, triple or dual display mode, you have access to the Setup mode for each channel displayed. Touch the **Setup Channel** buttons at the top of the screen to toggle back and forth between the setup screens for each channel. To change Salinity parameters, select the Salinity Setup button.



If you were in single display mode, you will access the Setup mode for the single channel displayed only.



Salinity Setup

XL20, 30, 50 and 60 meters

To Set Sample ID#

A sample ID is required if you wish to log data or activate a timed printing. Whenever this option is active, each time you touch Log Data on the salinity Measure screen, the salinity value along with date/time/channel and the sample ID will be sent to data storage.

You can manually enter an alphanumeric identification number of 10 characters for any sample or you can have the meter sequentially number your samples beginning at the number of your choice. You can also choose to deactivate the sample ID.

The Salinity Sample ID# is set the same way as previously described in Conductivity Setup. See **'Conductivity Setup: Set Sample ID#'** section for instructions.

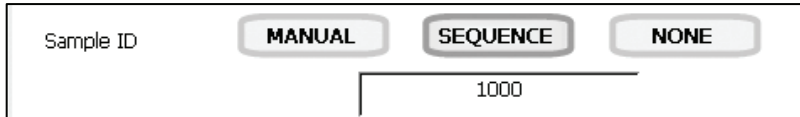

To Set Calibration Point(s)

This option also allows you to choose single-point or multi-point standardization. Use the single-point standardization option if you are measuring samples that close in value. Use the multi-point standardization option if you are measuring a wide range of samples. If a single point calibration is selected, there will be only one calibration factor for the entire range of operation. In the multi point mode, there will be one for each of the 4 ranges.

To select Calibration Point(s)

1. Touch **Single Point** or **Multi Point** to choose the method of standardization.



To Select Stable Indicator

This setup option lets you turn ON or OFF the stability indicator. When this function is turned on, the STABLE appears when the salinity reading is stable.

To select Stable indicator

1. Touch **ON** or **OFF** to turn stable indicator on or off.



To Select Auto Read Mode

You can use this meter when the Auto Read function is active or when it is inactive. When the Auto Read function is active, the meter will lock onto a reading when the meter recognizes it as stable. The meter will not deviate from this reading until Measure is touched. If the Auto Read function is inactive, then the meter will continuously monitor any Salinity fluctuations.

To select Auto Read Mode

1. Touch **MANUAL** or **AUTO** to choose the desired read mode.



Salinity Setup

XL20, 30, 50 and 60 meters

To Select Cell Constant

This setup option allows you to select the appropriate cell constant of the cell that you are using. There are three cell constants to choose from. Each is used for a different range of salinity.

The Salinity Cell Constant is set the same way as previously described in Conductivity Setup. See '**Conductivity Setup: Stable Indicator/Auto Read Mode/Cell Constant**' section for instructions.

Cell Constant	<input type="radio"/> 0.100 / cm	<input type="radio"/> 1.000 / cm	<input type="radio"/> 10.00 / cm
---------------	----------------------------------	----------------------------------	----------------------------------

When you change cell constants your calibration factor will automatically reset to default values. It is recommended that you standardize your meter to establish a new calibration factor.

To Set Default Temperature

Salinity is a temperature dependent measurement. This option allows you to select a default temperature that the meter will use along with the temperature coefficient to calculate a temperature corrected salinity measurement. If an ATC probe is used any value entered as a default temperature will be overridden in favor of the actual measured temperature of the solution provided to the meter by the ATC probe.

The default temperature can be set from -10°C to 110°C.

The Salinity Default Temperature is set the same way as previously described in Conductivity Setup. See '**Conductivity Setup: Select Reference Temperature**' section for instructions.

Default Temperature	<input type="text" value="25.0"/>	<input type="radio"/> C	<input type="radio"/> F	<input type="radio"/> K
---------------------	-----------------------------------	-------------------------	-------------------------	-------------------------

To Set Reference Temperature

This setup option allows you to select the reference temperature to be used in the determination of the salinity of your sample. The reference temperature can be set from 15°C to 30°C.

The Salinity Reference Temperature is set the same way as previously described in Conductivity Setup. See '**Conductivity Setup: Select Reference Temperature**' section for instructions.

Reference Temperature	<input type="text" value="25.0"/>	<input type="radio"/> C	<input type="radio"/> F	<input type="radio"/> K
-----------------------	-----------------------------------	-------------------------	-------------------------	-------------------------

To Set Temperature Coefficient

The temperature coefficient is a value that reflects the degree to which the sample's salinity is affected by temperature changes. The meter will use the set temperature coefficient along with the measured temperature provided by the ATC probe to calculate what the salinity would be at the selected reference temperature. If no ATC probe is being used, the meter will use the set default temperature in the calculation.

The temperature coefficient can be set from 0 to 10.000%.

The Salinity Temperature Coefficient is set the same way as previously described in section '**Conductivity Setup: Set Alarm Limits**'.

Temperature Coefficient	<input type="text" value="2.100"/>	%
-------------------------	------------------------------------	---

NOTE: The meter and probe with ATC will measure temperature even if the temperature coefficient is set to 0.0%, however a temperature correction will not be applied to the measurement.

Salinity Setup

XL20, 30, 50 and 60 meters

To Set Alarm Limits

This option allows you to set alarm limits for the salinity measuring mode. If the salinity value of the measurement is outside of the boundaries set by the minimum and maximum limits, audible and visual warnings will let you know that your sample measurement was outside of the set limits.

The Alarm Limit can be set from 0 to 90.000 ppt.

To set Alarm Limits

1. Touch **ON** or **OFF** to set the status of the alarm of salinity mode
2. Touch the **Low box** and use numeric keypad to enter the new limit values.
3. Touch **Enter** on the keypad to accept this limit and return to the salinity Setup screen.
4. Touch the **High box** and use numeric keypad to enter the new limit values.
5. Touch **Enter** on the keypad to accept this limit and return to the salinity Setup screen.

Alarm Limits	<input type="button" value="ON"/>	Low	<input type="text" value="0.000"/>	<input type="button" value="ppt"/>
	<input type="button" value="OFF"/>	High	<input type="text" value="500.000"/>	<input type="button" value="ppt"/>

To Set Print Criteria

This screen allows you to select which criteria are printed with the measurement when you print the data. The status of the current print criteria is displayed on the screen. The criteria option is active if **ON** appears to the right of the option. It is inactive if **OFF** appears to the right of the option. Any active criteria will be printed on demand.

The Salinity Print Criteria is set the same way as previously described in Conductivity Setup. See '**Conductivity Setup: Set Print Criteria**' section for instructions.

Print Criteria	<input type="button" value="Touch here to edit"/>
----------------	---

Salinity Setup

XL20, 30, 50 and 60 meters

To Set Data Storage Criteria

This screen allows you to select which criteria are stored in the data logger with the measurement when you store the data. The status of the current data storage criteria is displayed on the screen. The criteria option is active if **ON** appears to the right of the option. It is inactive if **OFF** appears to the right of the option. Any active criteria will be stored on demand.

The Salinity Data Storage Criteria is set the same way as previously described in Conductivity Setup. See '**Conductivity Setup: Data Storage Criteria**' section for instructions.



To Set Display Criteria

This screen allows you to choose what information you would like to be displayed on the salinity Measure screen, particularly the information contained in the data box at the bottom of the Measurement screen. The status of the current display criteria is displayed on the screen. The criteria option is active if **ON** appears to the right of the option. It is inactive if **OFF** appears to the right of the option.

The Salinity Display Criteria is set the same way as previously described in Conductivity Setup. See '**Conductivity Setup: Set Display Criteria**' section for instructions.



To View Stored Data

The XL20, XL30, XL50 and XL60 have a memory capacity to store up to 1000 data points. The View Stored Data screen allows you to sort and look at specific data points stored in the meter based on the meters memory capacity. The stored data can be sorted by any of the parameters available in the screen header.

The meter stores salinity data under the following parameters:

Reading	Temperature Coefficient
Date / Time / Channel	Cell Type
Sample Id	Last Standardizations
Temperature	Meter Model / Serial No
Reference Temperature	Operator

Viewing Stored Salinity Data is done the same way as previously described in Conductivity Setup. See '**Conductivity Setup: View Stored Data**' section for instructions.



pH Operation: About pH Measurement

XL15, 20, 25, 50 and 60 meters

For the XL15, XL20, XL25, XL50 and XL60 meters, in the pH measurement mode, you will be able to measure the pH of a wide variety of samples. Before measuring pH, you will need to standardize the meter using buffers with known pH values. It is good practice to standardize the meter frequently using a minimum of two buffers. Using two buffers allows the meter to calculate and display an actual slope for the electrode, and therefore produce more accurate measurements. If there is no standardization in the memory of the meter or if only one buffer has been used to standardize the meter, the slope value will appear as ".....".

You can standardize your meter using automatic or manual buffer recognition. With the Automatic buffer recognition activated (**ON**), the meter will automatically recognize the buffers from the chosen buffer group and flash the current buffer. When the reading is stable, you must confirm the buffer.

In the Manual buffer recognition mode, you must enter the buffer value during the standardization procedure. The meter will flash the manually entered buffer you must confirm the buffer when the reading is stable. During the standardization procedure, you may accept the buffer value before the meter recognizes it as stable by touching confirm.

See '**pH Setup: Select Auto Read Mode**' section to select desired buffer recognition.

Remember to setup your pH measuring mode parameters. Refer to the pH Setup section for instructions. Connect the electrodes you will be using to the meter.

Touch the **Channel 1, 2, or 3** buttons (single pH channel screen) to access the standardization screen. Standardization is not available from multiple display modes.



pH measure screen without standardization

pH Operation: Standardizing

XL15, 20, 25, 50 and 60 meters

To Standardize the meter with Auto Buffer Recognition

1. Make sure **Auto Buffer Recognition** is selected in the Setup screen.
2. Immerse your rinsed electrode(s) and temperature probe in a buffer solution from the selected buffer group that you chose during the pH setup process and stir gently. The selected buffer group appears on the standardization screen.
3. Touch **Standardize** on the Channel 1, 2 or 3 pH measure screen to access the standardization screen.
4. Touch **Clear** if necessary to delete all previous standardization values. If the screen says "**Not standardized**" proceed to step 5.
5. The screen will flash a beaker icon of the buffer solution you have selected. When the reading is stable, **STABLE** appears on the screen.
6. Touch **Confirm** to standardize buffer. The meter will return to the pH measure screen.
7. Touch **Standardize** on the pH measure screen to access the standardization screen.
Repeat process to standardize with up to 5 buffers.

The efficiency of the electrode is reported as the slope. When doing a multi-point standardization, the slopes of the individual segment are calculated by the meter. The slope that appears on the screen is the slope applicable to that zone (in which the measurement is currently being made).

For optimal results, the meter should be standardized at a minimum of every 8 hours. For more accurate measurements, the meter should be standardized more frequently.

If there is no previous standardization, there is no need to click the **Clear** button. If your meter already has a calibration in memory, click **Clear** if you need to clear the previous calibration values.

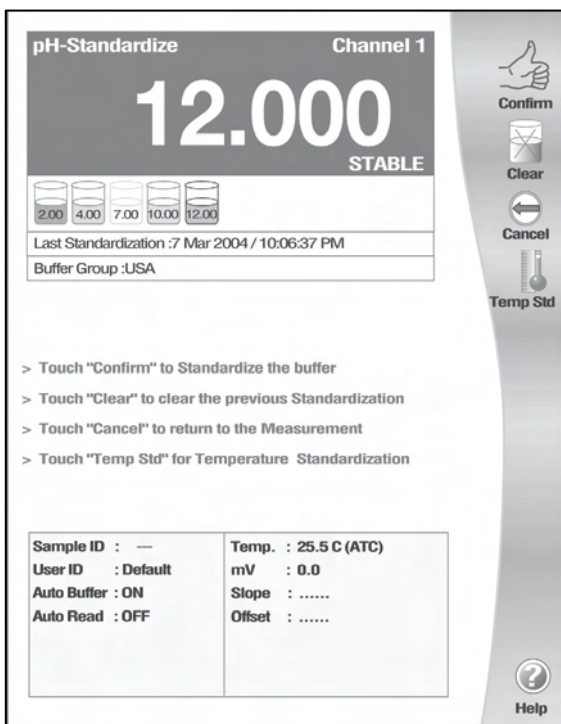

pH calibration screen with Auto Buffer Recognition

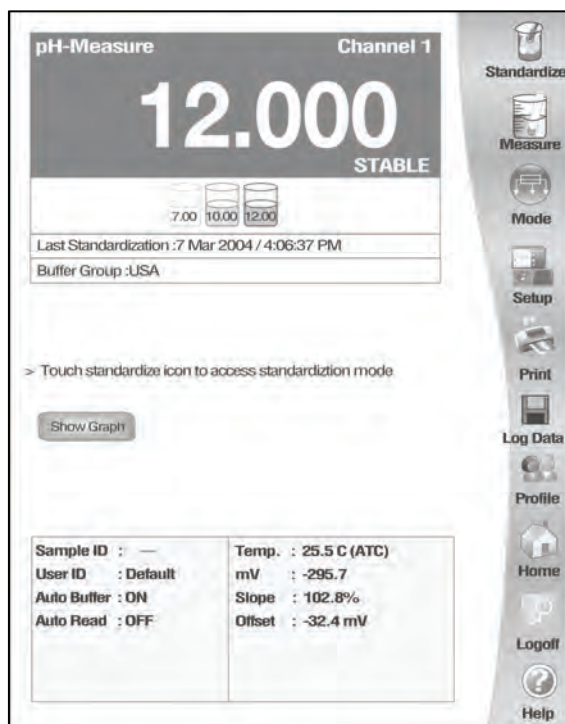

Once the meter is calibrated, the pH Measure screen shows the buffers that have been standardized and last standardization time/date

pH Operation: Standardizing

XL15, 20, 25, 50 and 60 meters

To standardize the meter with Manual Buffer Recognition

The Manual mode requires a minimum two-point calibration. When you press the Enter key after the first calibration point, a message appears: "Minimum 2 buffers need to be standardized to apply the standardization in measurement".

1. Make sure Manual Buffer Recognition is selected in the Setup screen.
2. Immerse your rinsed electrode(s) and temperature probe in a buffer solution from the selected buffer group that you chose during the pH setup process and stir gently. The selected buffer group appears on the standardization screen.
3. Touch **Standardize** on the Channel 1, 2, or 3 pH measure screen to access the standardization screen.
4. Touch **Clear** if necessary to delete all previous standardization values. If the screen says "**Not standardized**" proceed to step 5.
5. The screen will flash each beaker icon once, then a numeric keypad will appear. Using the displayed keypad input the value of the buffer that you are using to standardize the meter and then touch **Enter**. The meter now shows the buffer value in the flashing beaker.
6. When the reading is stable, **STABLE** appears on the screen. Touch Confirm to standardize the buffer. The meter will then return to the pH measure screen.
7. Touch **Standardize** on the pH measure screen to access the standardization screen. Repeat process to standardize with up to 5 buffers.

If there is no previous standardization, there is no need to click the Clear button. If your meter already has a calibration in the memory, use the Clear button if you need to clear the previous calibration values.

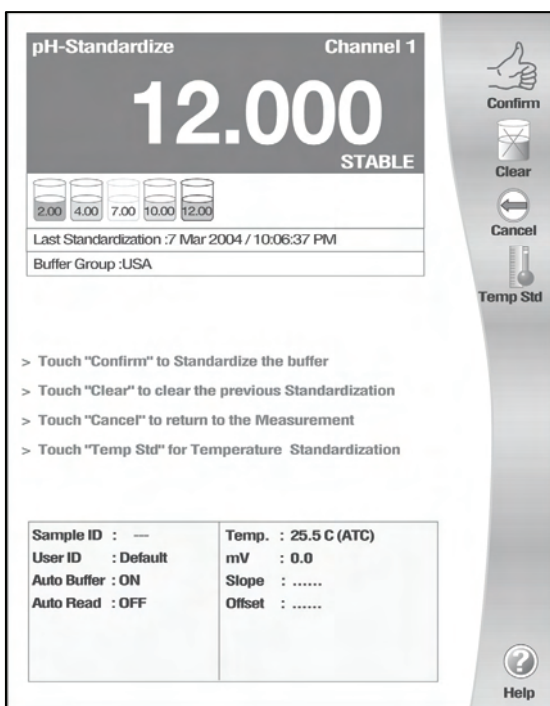

pH calibration screen with Manual Buffer Recognition

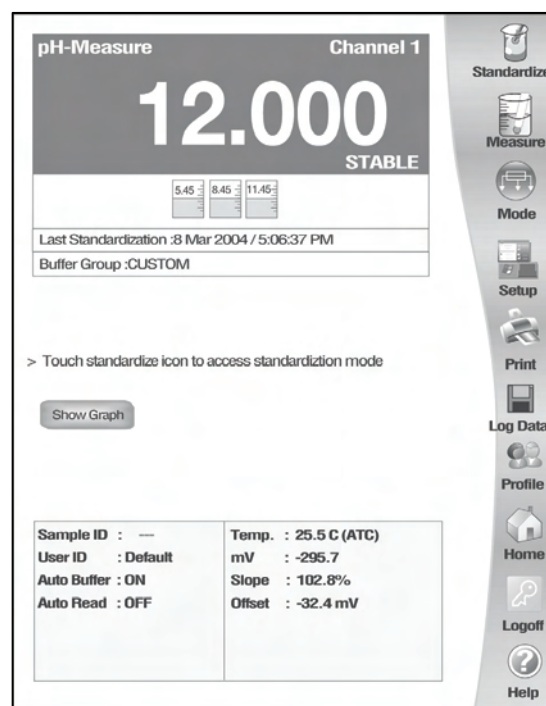

Once meter is calibrated, pH Measure screen shows standardized buffers and last standardization time/date

pH Operation: Temperature Standardization

XL15, 20, 25, 50 and 60 meters

To Standardize Temperature of the Meter

1. Touch **Standardize** on the pH measure screen to access the standardized screen.
2. Immerse your ATC probe into a solution of known temperature, such as a temperature bath, for a few minutes while temperature stabilizes.
3. Make sure ATC probe is attached to meter.
4. Touch **Temp Std** to access temperature standardization
5. The Temperature Standardization screen appears. Check the current temperature displayed with that of the solution of known temperature. Touch the **Standardization Temperature** box and use numeric keypad to enter the current temperature. Press **Enter** to confirm value.
6. Touch **OK** to confirm Standardization Temperature and return to the pH Measure screen. Touch **Reset** to reset and enter a new standardization temperature. Touch **Cancel** to cancel temperature standardization and return to the pH Standardization screen.

Note: The meter will not allow entered value to exceed $\pm 5^\circ$ of the ATC probe value. If entered value exceeds $\pm 5^\circ$ an error window will appear and you will have to re-enter value or cancel out of the temperature screen. This might indicate that you have a problem with the ATC probe.

Temperature Standardization

Current Temperature: 25.7 [C] [F] [K]

Standardization Temperature: [] [C] [F] [K]

[OK] [Cancel] [Reset]

pH Operation: pH Measurements

XL15, 20, 25, 50 and 60 meters

The measure screen provides readout of the current sample measurement. You can use this meter when the Auto Read function is active or when it is inactive.

When the auto read function is active, the meter will lock onto a reading when the meter recognizes it as stable. The meter will not deviate from this reading until the Measure button is touched.

If the Auto Read mode is inactive, then the meter will continuously monitor the pH of the sample and the measure display screen will indicate any fluctuation in the sample pH. Regardless of the status of the Auto Read mode, **STABLE** will flash as the meter recognizes the measurement as stable.

Once the meter is standardized, you are ready to take pH measurements of your sample.



pH Measure screen with Auto Read OFF

To Measure pH of a Sample with Auto Read ON

1. Immerse the rinsed electrode(s) in the sample and stir gently.
2. Touch **Measure** to begin measuring your sample. The meter will accept the reading and display **STABLE*** when the measurement meets the selected stability criteria.

OR

To Measure pH of a Sample with Auto Read OFF

1. Immerse the rinsed electrode(s) in the sample and stir gently.
2. Record the reading once the measurement has become stable. **STABLE*** will appear once the meter recognizes that the measurement is stable.

* Please note that **STABLE** will only appear if you have completed a successful two point calibration.

NOTES: You can access other functions of the meter with the remaining buttons on the measure screen.

- Touching **Setup** will access the pH Setup screen.
- Touching **Measure** will initiate a new measurement of a sample with Auto Read ON.
- At anytime, you can touch **Mode** to access another mode of operation.

pH Operation: Graphing Function

XL15, 20, 25, 50 and 60 meters

You can view your data as a real-time graph on screen to display mV changes over time. Time is plotted in seconds. The graph refreshes every hour from the start of graphing.

1. To view your data in graph format, touch **Show Graph**.
2. To start plotting data, touch **Start Plotting**. To stop plotting data, touch **Stop Plotting**.
Once the plotting is stopped, the displayed graph can be dragged left/right and up/down.
3. To view your data more closely, touch. **Zoom In**. To view more data at one time, touch **Zoom Out**.
4. To hide the graph, touch **Hide Graph**.

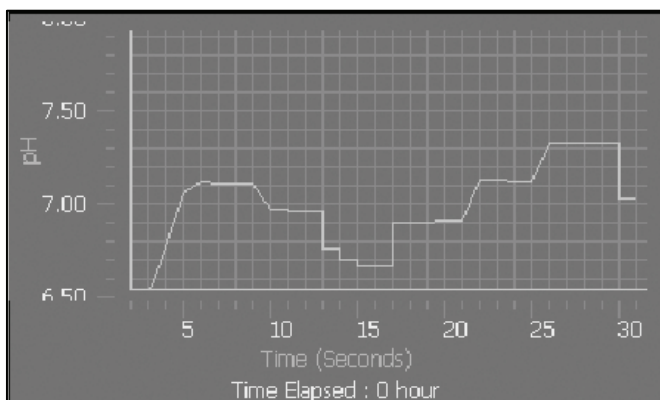
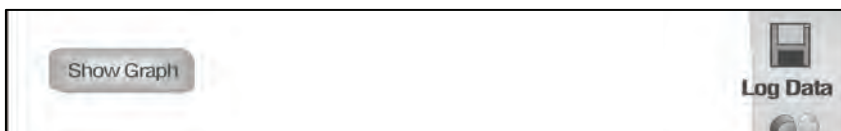

mV Operation: About mV Measurement

XL15, 20, 25, 50 and 60 meters

This mode is used to measure oxidation/ reduction potential (ORP/redox), perform titration and to verify the function of the meter. The mV measure function allows you to continuously monitor the mV potential of the electrodes in use. This can be done in either absolute or relative mV.

In the millivolts mode, the current millivolt output from the electrodes being used is monitored and displayed on the screen. The meter will continually monitor the millivolts reading in this mode and will not lock onto a single reading. However, once the reading has become stable, a **STABLE** will be displayed. Remember to setup your mV measuring mode parameter; refer to mV Setup section for instructions.

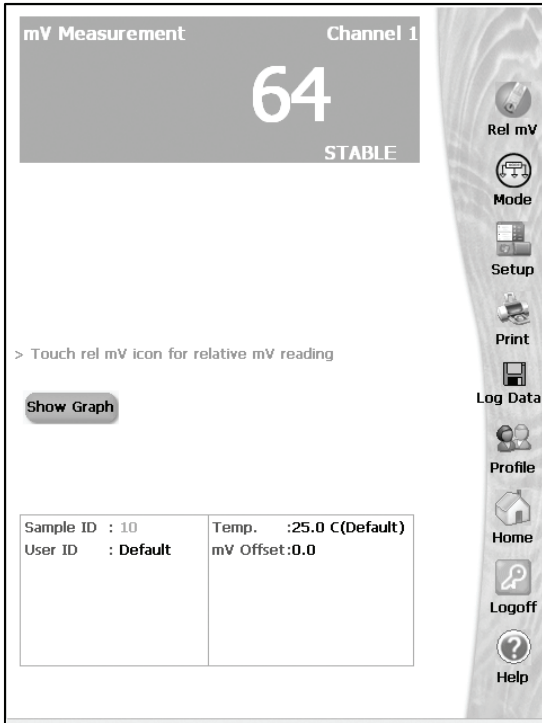

Absolute mV measurement screen



Relative mV measurement screen

mV Operation: mV Measurement

XL15, 20, 25, 50 and 60 meters

In the mV mode, you will be able to make measurements in either absolute or relative millivolts, access the mV Setup screens and print your results to a printer or a computer.

Connect the electrodes you will be using to the meter.

Absolute mV Measurements

1. Access the mV measure screen from the main screen
2. Immerse the rinsed electrode(s) in the sample and stir gently.
3. Record the measurement when STABLE is displayed.

Relative mV Standardization and Measurement

In the relative mV mode, we have an option either to adjust the displayed value within a ± 150 mV window or equate it to zero.

1. Access the mV Measure screen from the main screen.
2. Immerse the rinsed electrode(s) in the mV (ORP) standard solution and wait for **STABLE** to appear.
3. Touch **rel mV** to access the Relative mV screen. When rel mV is touched, a dialog box appears.
4. Touch **SET** to set relative mV using numeric keypad and press **Enter** to confirm value.

OR

Touch **DEFAULT** to accept the default value (0 mV)

OR

Touch **CANCEL** to cancel and return to previous screen.

5. The meter is now ready to take relative mV measurements.

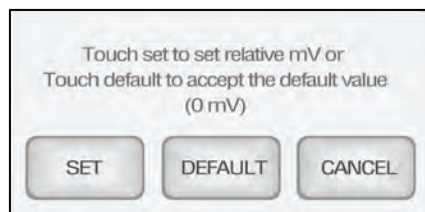

Rinse the electrode with water and shake dry. Do not wipe the electrode. Wiping the electrode can cause a static charge on the glass bulb that will result in inaccurate readings.

mV Operation: Graphing Function

XL15, 20, 25, 50 and 60 meters

You can view your data as a real-time graph on screen to display mV changes over time. Time is plotted in seconds. The graph refreshes every hour from the start of graphing.

1. To view your data in graph format, touch **Show Graph**.
2. To start plotting data, touch **Start Plotting**. To stop plotting data, touch Stop Plotting. Once the plotting is stopped, the displayed graph can be dragged left/right and up/down.
3. To view your data more closely, touch. **Zoom In**. To view more data at one time, touch **Zoom Out**.
4. To hide the graph, touch **Hide Graph**.

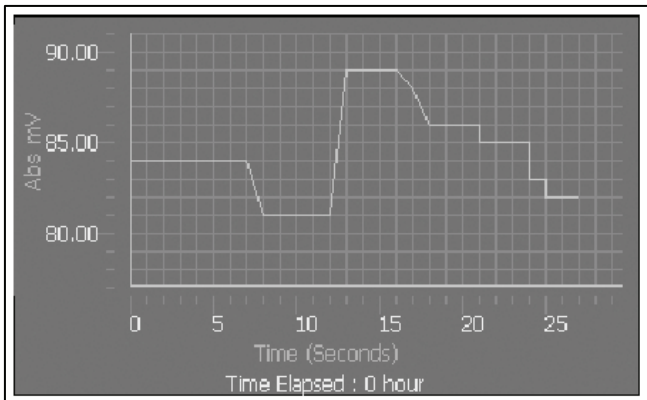

Ion Operation: About Ion Measurement

XL25, 50 and 60 meters

The accumet XL25, XL50 and XL60 meter offers you unparalleled versatility with respect to ion analysis.

You can choose:

- one of 6 methods of analysis
- the specific electrode you will be working with
- the units that you would like the meter to use when reporting the ion concentration

The Ion Measure screen displays the direct readout of sample concentration in the desired units, as well as the time and date of the last calibration. The standards used in the calibration and the slope of the electrode are also displayed on the screen. It is important to note that the concentration reported by the meter is actually the concentration of free uncomplexed ions in your solution.

Connect the electrodes you will be using to the meter.

Remember to setup your Ion measuring mode parameters. Refer to Ion setup section for instructions.

Ion Measurement (ppm) Channel 1

4.993 E-4

STABLE

Sample ID : 13	Temp. :25.0 C(Default)
User ID : Default	mV :-0.6
Ion Type : AMMONIA	Slope :100.4 %
Auto Read : OFF	Blank Ofs. :.....

Last Standardization :DRWS/1 Jan 2002 / 5:35:56 PM

Ion Measurement (ppm) Channel 2

9.586 E10

Sample ID : 23	Temp. :25.0 C(Default)
User ID : Default	mV :412.8
Ion Type : POTTASIAM	Slope :100.3 %
Auto Read : OFF	Blank Ofs. :.....

Last Standardization :DRWS/1 Jan 2002 / 5:38:45 PM

Channel 1

Channel 2

Mode

Setup

Log Data

Profile

Home

Logoff

Help

Ion Operation: Direct Reading Methods

XL25, 50 and 60 meters

There are two direct reading methods:

Direct Reading with Standards and

Direct Reading with Blank Offset.

These types of measurements allow you to directly read the concentration of your sample after standardizing the meter with ion standards of known values or blank values.

Direct Reading with Standards

This is the most common method of ion measurement. You can directly read the concentration of the sample after standardizing the meter with ion standards. An ionic strength adjuster (ISA) is added to both the standards and the sample. Two to five standards are used to standardize the meter. The standards should bracket the expected value of the sample.

To Standardize the Meter Using Direct Reading with Standards

You must use a minimum of two standards to standardize the meter. Make sure you have selected "Direct Reading with Standards" on the Ion Setup screen.

1. Add ionic strength adjuster to your standard.
2. Immerse your rinsed electrode(s) into the standard solution and stir gently.
3. Touch the **Standardize** button on the Ion Measure screen to access the standardization screen.
4. Touch **Clear** if necessary to remove a previous standardization. If the screen says "Not Standardized," proceed to step 5.
5. The screen will flash each standard icon once, then a numeric keypad will appear. Using the displayed keypad input the value of the standard that you are using to standardize the meter. Touch **Enter** to accept this value. The meter now shows the value of the standard solution in the flashing beaker.
6. Wait until **Stable*** appears on the screen. Press Confirm button once to confirm the standardization. To manually override the stability requirement, press **Confirm** before the stable message appears after the ion beaker starts flashing with the standard value.
7. Touch **Standardize** and repeat steps 3-7 with up to 5 standards. A minimum of two standards is required to standardize the meter in this mode.
- 8.

* Please note that **STABLE** will only appear if you have completed a successful two point calibration.

Updating the standardization is not possible. Once five point standardization is complete, if you press the **Standardize** icon the meter will prompt the message to clear the previous standardization.

If the meter has not been standardized with at least two standards, a series of dashes will appear in place of a measurement value.



Ion Operation: Direct Reading Methods

XL25, 50 and 60 meters

Measuring Ion Concentration in the Direct Reading with Standards mode

With Auto Read on

1. Add Ionic strength adjuster to the sample.
2. Immerse the ion selective electrode in the stirring sample.
3. Touch **Measure** to begin measuring your sample. The meter will accept the reading and display **STABLE*** when the measurement meets the selected stability criteria. The measure screen will fix onto this measurement and will not deviate until **Meas** is touched.
Repeat steps 1-3 with additional samples.

* Please note that **STABLE** will only appear if you have completed a successful two point calibration.

With Auto Read off

1. Add Ionic strength adjuster to the sample.
2. Immerse the ion selective electrode into the stirring sample. The meter will continually monitor the ion concentration value. When the meter recognizes the reading as stable, **STABLE** is displayed on the measure screen. With the **Auto Read** function deactivated, the display on the measure screen will indicate any deviation in the concentration.
3. Repeat steps 1-2 with additional samples.

The screenshot displays the meter's interface for ion measurement. At the top, it shows 'Ion Measurement (ppm) Channel 1' and a large reading of '5.000 E-4' with 'STABLE' below it. Two small graphs show calibration points at '5.0E-3' and '5.0E-2'. Below these are fields for 'Last Standardization : 1 Jan 2002 / 5:35:56 PM' and 'Current Ion Method : Direct Reading with Standards'. A 'Show Graph' button is present. At the bottom, a table lists parameters: Sample ID : 13, User ID : Default, Ion Type : AMMONIA, Auto Read : OFF, Temp. : 25.0 C(Default), mV : -0.6, Slope : 100.4 %, and Blank Ofs. : A vertical sidebar on the right contains icons for Standardize, Measure, Mode, Setup, Print, Log Data, Profile, Home, Logoff, and Help.

> Touch standardize icon to access standardization mode

Sample ID : 13	Temp. : 25.0 C(Default)
User ID : Default	mV : -0.6
Ion Type : AMMONIA	Slope : 100.4 %
Auto Read : OFF	Blank Ofs. :

Ion Operation: Direct Reading Methods

XL25, 50 and 60 meters

Direct Reading with Blank Offset

This method presents you with the ability to measure samples with low level concentrations of the ion of interest. It eliminates background interference by subtracting the value of a blank concentration from the value for the sample.

See ISE Theory on '**Appendix: ISE Theory**' section.

To Standardize the Meter Using Direct reading with Blank Offset

You will need to standardize the meter with one blank and a minimum of two standards. Make sure that you have selected "Direct Reading with Blank Offset" on the Ion Setup screen.

1. Add ionic strength adjuster to the standards and the blank.
2. Immerse the ion selective electrode in the blank or standard containing the lowest concentration of the ion of interest.
3. Stir the standard or blank.
4. Touch **Standardize** to initiate the standardization process. At this point, the meter will display the question "Is this reading standard or blank?"
5. Touch **STANDARD** if the sample that the electrode is immersed in is an ion standard solution.

OR

Touch **BLANK** if the sample that the electrode is immersed in is the blank solution.

If you touched STANDARD

6. The Meter goes to the Standardization screen. The screen will flash each standard icon once, then a numeric keypad will appear. Using the displayed keypad input the value of the standard that you are using to standardize the meter. Touch **Enter** to accept this value.

The meter accepts the value and starts blinking. When the **Stable** icon appears on the screen, press the Confirm icon to confirm the standardization.

If you touched BLANK

7. The meter will return to the Ion Measure screen and a beaker icon labeled blank will be displayed. The blank value will be displayed on the bottom display panel.
Repeat if the meter has not been standardized with at least 2 standards of known ion concentration.

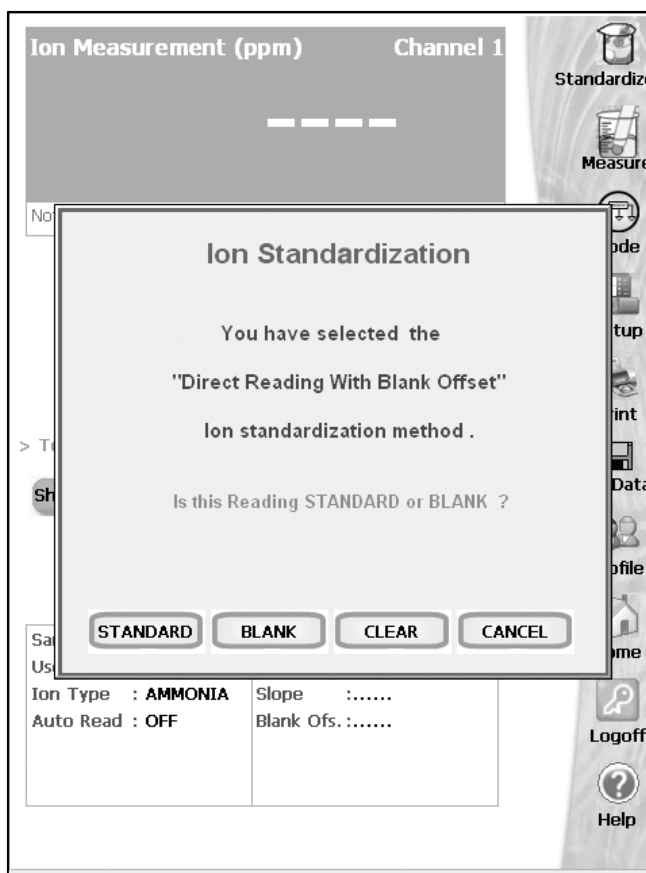

Ion Operation: Direct Reading Methods

XL25, 50 and 60 meters

Measuring Ion Concentration in the Direct Reading with Blank Offset Mode

With Auto Read on

1. Add ionic strength adjuster to the samples.
2. Immerse the ion selective electrode in the stirring sample
3. Touch **Measure**. When the meter recognizes the reading as stable, **STABLE*** will appear on the screen. The value that appears on the screen is the value of the sample minus the value of the blank reading. The measure screen will fix on this measurement and will not deviate until **Measure** is touched again.
4. Repeat steps 1-3 with additional samples. The meter will update the reading each time **Measure** is touched.

* Please note that **STABLE** will only appear if you have completed a successful two point calibration.

With Auto Read off

1. Add ionic strength adjuster to the sample.
2. Immerse the ion selective electrode in the stirring sample. The meter will continually monitor the ion concentration value. When the meter recognizes the reading as stable, **STABLE** is displayed on the measure screen. With the **Auto Read** function deactivated, the display on the measure screen will indicate any deviation in the concentration reading.

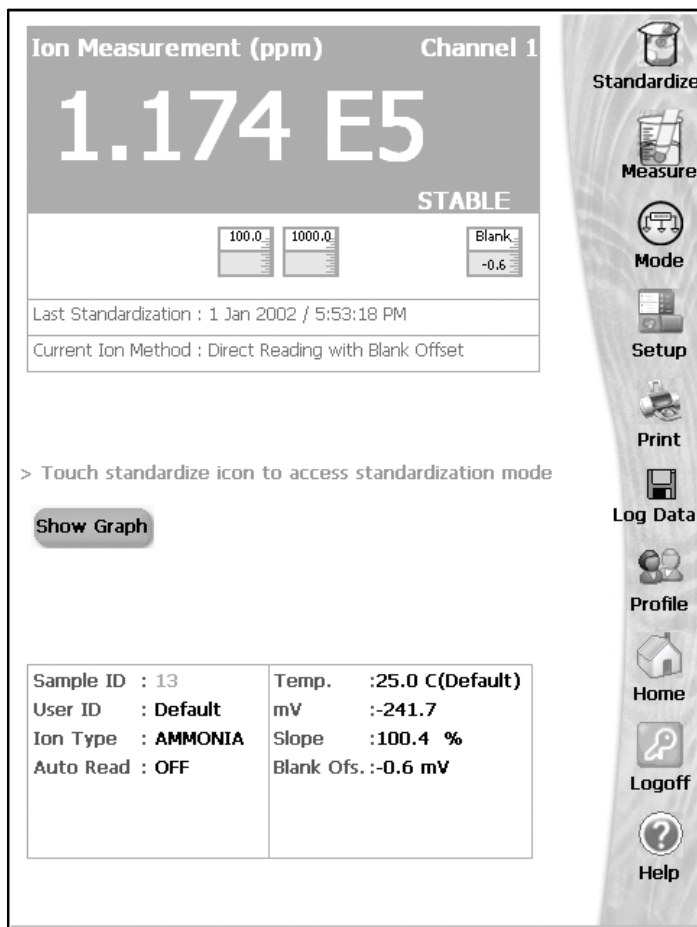

Ion Operation: Incremental Methods

XL25, 50 and 60 meters

The incremental methods which include known addition, known subtraction, analate addition and analate subtraction are particularly useful with samples containing complex ionic backgrounds which cannot be matched in standards. They are also useful with occasional samples whose temperatures vary. More information on these methods is available in the ISE Theory Section (see '**Appendix: ISE Theory**' section).

Standardizing the meter for all incremental methods

Prior to conducting an analysis using any of the incremental methods, it is necessary to standardize the meter with at least two standards. This will establish a slope value for the electrode in use. The slope value is required in the incremental method calculations which yield the ion concentration of the sample. See ISE Theory on '**Appendix: ISE Theory**' section.

Make sure you have selected one of the incremental methods (known addition, known subtraction, analate addition, or analate subtraction) in the Ion Setup screen.

1. Add ionic strength adjuster to the standards.
2. Immerse the ion selective electrode in the stirring standard. Always begin standardization with the least concentrated ion standard.
3. Touch **Standardize** to initiate standardization.
4. Use the keypad to enter value of the standard.
5. Touch **Enter** on the keypad to accept this value. If you have entered a value in error, touch **BS** to clear the value and key in a new value.
6. The meter accepts the value and the standard icon starts blinking. When the Stable icon appears on the screen, press the **Confirm** icon to confirm the standardization.
7. Repeat with additional standards (up to five).

Ion Operation: Known Addition Method

XL25, 50 and 60 meters

Measuring Concentration in Samples Using the Known Addition Method

When performing known addition, you will add an aliquot of standard solution containing the ionic species of interest to a known volume of your sample. The mV readings of the sample are taken before and after the addition of the standard. The concentration of the sample can then be calculated based upon the difference in the mV readings.

The use of the incremental methods requires that certain parameters be identified. In addition to the millivolt outputs of the electrode(s) in both the sample and the sample plus the standard, it is necessary to enter into the meter the volume of the sample, the volume of the standard, the volume of the Ionic Strength Adjuster (ISA) if used, the concentration of the standard and as previously stated the slope of the electrode in use.

Your Accumet research meter will prompt you through the method, permitting you to enter the appropriate parameters at the appropriate time. When the meter has all of the data needed for the calculation, it will display the ion concentration of the sample as well as the parameters entered for the calculation.

The standard concentration should be high enough to nearly double the sample ion concentration after its addition. However, the standard volume should not significantly impact the sample volume. A 1:100 ratio of standard to sample ratio is optimal. For a monovalent electrode, the standard addition should result in a 15-30 mV change. For a divalent electrode, a 7-10 mV change is adequate. If the millivolt change is too high, the addition of the standard may affect the ionic strength and therefore the activity coefficients. This could result in inaccurate measurements. If the millivolt change is too small, readability errors are enhanced. See ISE Theory on '**Appendix: ISE Theory**' section.

Taking a Known Addition Measurement

1. Immerse the ion selective electrode in a known volume of the sample solution.
2. Stir the sample.
3. Wait for the reading to stabilize (**STABLE** will appear). Touch **KA** to take the first mV reading of sample.
4. Add a known volume of standard solution to the sample.
5. Wait for the reading to stabilize (**STABLE** will appear). Touch **KA** to take the second mV reading of sample.
6. Use the keypad to enter the sample volume.
7. Touch **Enter** to accept the value.
8. Use the keypad to enter the standard volume.
9. Touch **Enter** to accept the value.
10. Use the keypad to enter the volume of ionic strength adjuster used. If no ISA was used, enter a value of zero.
11. Touch **Enter** to accept the value.
12. Use the keypad to enter the concentration of the standard solution added to the sample.
13. Touch **Enter** to accept the value. Your Known Addition result is now displayed.
14. Touch **Print** to send the data to a printer

OR

Touch **OK** to return to the Measure screen for a new measurement.

Ion Operation: Known Addition Method XL25, 50 and 60 meters

Ion Measurement(mV)
Channel 1

-241.7

100.0

1000.0

Blank
-0.6

Last Standardization : 1 Jan 2002 / 5:53:18 PM

Current Ion Method : Known Addition

> Touch KA to take 1st reading using KNOWN ADDITION

> Touch standardize icon to access standardization mode

Show Graph

Sample ID : 13	Temp. :25.0 C(Default)
User ID : Default	mV :-241.7
Ion Type : AMMONIA	Slope :100.4 %
Auto Read : OFF	Blank Ofs. :-0.6 mV

Standardize
KA
KN ADD
Mode
Setup
Print
Log Data
Profile
Home
Logoff
Help

Ion Measurement(mV)
Channel 1

12.6

Known Addition Result

15.3

ppm

Calculated Slope : 61.0 mV

Reading 1 : 12.2 mV

Reading 2 : 12.2 mV

Sample Volume : 100.0

Standard Volume : 10.0

ISA Volume : 50.0

Standard Concentration : 10.0

OK

PRINT

Standardize
KA
KN ADD
Mode
Setup
Print
Log Data
Profile
Home
Logoff
Help

Ion Operation: Known Subtraction Method

XL25, 50 and 60 meters

Measuring Concentration in Samples Using the Known Subtraction Method

The procedure for known subtraction is very similar to that for known addition method (see '**Ion Operation: Known Addition Method**' section). An aliquot of standard is added to a known volume of the sample. The difference is that the standard does not contain the same ionic species that you are trying to measure in the sample. Instead, it contains an ion that will complex or precipitate the ion of interest, removing it from the sample.

Like known addition, the mV readings are taken before and after the standard is added to the sample and the difference in mV values can be used to calculate the concentration of free ions of interest in the sample. This method will also require you to enter values of certain parameters in order to obtain an ion concentration. See ISE Theory on '**Appendix: ISE Theory**' section.

Taking a Known Subtraction Measurement

1. Immerse the ion selective electrode in a known volume of the sample solution.
2. Stir the sample.
3. Wait for the reading to stabilize (**STABLE** will appear). Touch **KS** to take the first reading.
4. Add a known volume of standard solution to the sample.
5. Wait for the reading to stabilize (**STABLE** will appear). Touch **KS** to take the second reading.
6. Use the keypad to enter the sample volume.
7. Touch **Enter** to accept the value.
8. Use the keypad to enter the standard volume.
9. Touch **Enter** to accept the value.
10. Use the keypad to enter the volume of ionic strength adjuster used. If no ISA was used, enter a value of zero.
11. Touch **Enter** to accept the value.
12. Use the keypad to enter the concentration of the standard solution added to the sample.
13. Touch **Enter** to accept the value. Your Known Subtraction result is now displayed.
14. Touch **Print** to send the data to a printer

OR

Touch **OK** to return to the Measure screen for a new measurement.

Ion Operation: Known Subtraction Method XL25, 50 and 60 meters

Ion Measurement(mV)
Channel 1

-241.7

STABLE

100.0

1000.0

Blank
-0.6

Last Standardization : 1 Jan 2002 / 5:53:18 PM
 Current Ion Method : Known Subtraction

> Touch KS to take 1st reading using KNOWN SUBTRACTION

> Touch standardize icon to access standardization mode

Show Graph

Sample ID : 13	Temp. :25.0 C(Default)
User ID : Default	mV :-241.7
Ion Type : AMMONIA	Slope :100.4 %
Auto Read : OFF	Blank Ofs. :-0.6 mV

Standardize
 KN SUB
 Mode
 Setup
 Print
 Log Data
 Profile
 Home
 Logoff
 Help

Ion Measurement(mV)
Channel 1

00

Known Subtraction Result

705.8 ppm

Calculated Slope	: -59.1 mV
Reading 1	: -0.6 mV
Reading 2	: 9.9 mV
Sample Volume	: 100.0
Standard Volume	: 50.0
ISA Volume	: 25.0
Standard Concentration	: 100.0

OK
PRINT

Standardize
 KN SUB
 Mode
 Setup
 Print
 Log Data
 Profile
 Home
 Logoff
 Help

Ion Operation: Analate Addition Method

XL25, 50 and 60 meters

Measuring Concentration in Samples Using the Analate Addition Method

The analate addition method is useful when your sample is at an elevated temperature and you want to negate the effect that temperature will have on the concentration calculation. This method is also useful if you have only a small amount of sample available.

The analate addition method differs only slightly from the known addition method (see '**Ion Operation: Known Addition Method**' section). The difference is the solution that you are taking your initial mV reading in is actually the standard and not the sample of interest. The difference in mV readings of the standard before and after the sample is added is used to calculate the concentration of the ion of interest. With the analate addition method, both the sample and the standard solution contain the ionic species of interest. See ISE Theory on '**Appendix: ISE Theory**' section.

Taking an Analate Addition Measurement

1. Immerse the ion selective electrode in a known volume of the standard solution.
2. Stir the standard.
3. Wait for the reading to stabilize (**STABLE** will appear). Touch **AA** to take the first reading.
4. Add a known volume of sample solution to the standard solution
5. Wait for the reading to stabilize (**STABLE** will appear). Touch **AA** to take the second reading.
6. Use the keypad to enter the sample volume.
7. Touch **Enter** to accept the value.
8. Use the keypad to enter the standard volume.
9. Touch **Enter** to accept the value.
10. Use the keypad to enter the volume of ionic strength adjuster used. If no ISA was used, enter a value of zero.
11. Touch **Enter** to accept the value.
12. Use the keypad to enter the concentration of the standard solution.
13. Touch **Enter** to accept the value. Your Analate Addition result is now displayed.
14. Touch **Print** to send the data to a printer

OR

Touch **OK** to return to the Measure screen for a new measurement.

Ion Operation: Analate Addition Method XL25, 50 and 60 meters

Ion Measurement(mV) Channel 1

-241.7

100.0 1000.0 Blank
-0.6

Last Standardization : 1 Jan 2002 / 5:53:18 PM
Current Ion Method : Analate Addition

> Touch AA to take 1st reading using ANALATE ADDITION
> Touch standardize icon to access standardization mode

Show Graph

Sample ID : 13	Temp. :25.0 C(Default)
User ID : Default	mV :-241.7
Ion Type : AMMONIA	Slope :100.4 %
Auto Read : OFF	Blank Ofs. :-0.6 mV

Standardize
AA
AN ADD
Mode
Setup
Print
Log Data
Profile
Home
Logoff
Help

Ion Measurement(mV) Channel 1

12.7

Analate Addition Result

60.0 ppm

Calculated Slope : 61.0 mV
Reading 1 : 12.4 mV
Reading 2 : 12.4 mV
Sample Volume : 10.0
Standard Volume : 100.0
ISA Volume : 50.0
Standard Concentration : 10.0

OK PRINT

Last
Curr
> To
> To
Shc

Standardize
AA
AN ADD
Mode
Setup
Print
Log Data
Profile
Home
Logoff
Help

Ion Operation: Analate Subtraction Method

XL25, 50 and 60 meters

Measuring Concentration in Samples Using the Analate Subtraction Method

The analate subtraction method is useful when no ion specific electrode is available to measure the ion of interest directly. Like known subtraction the sample and the standard contain different ionic species. However, the ion being measured is in the standard and not in the sample. The reduction of free ions in the standard solution is proportional to the concentration of the ion of interest in the sample. See ISE Theory on '**Appendix: ISE Theory**' section.

Taking an Analate Subtraction Measurement

1. Immerse the ion selective electrode in a known volume of the standard solution.
2. Stir the standard.
3. Wait for the reading to stabilize (**STABLE** will appear). Touch **AS** to take the first reading.
4. Add a known volume of sample solution to the standard.
5. Wait for the reading to stabilize (**STABLE** will appear). Touch **AS** to take the second reading.
6. Use the keypad to enter the sample volume.
7. Touch **Enter** to accept the value.
8. Use the keypad to enter the standard volume.
9. Touch **Enter** to accept the value.
10. Use the keypad to enter the volume of ionic strength adjuster used. If no ISA was used, enter a value of zero.
11. Touch **Enter** to accept the value.
12. Use the keypad to enter the concentration of the standard solution.
13. Touch **Enter** to accept the value. Your Analate Subtraction result is now displayed.
14. Touch **Print** to send the data to a printer

OR

Touch **OK** to return to the Measure screen for a new measurement.

Ion Operation: Analate Subtraction Method XL25, 50 and 60 meters

Ion Measurement(mV)
Channel 1

65.5

STABLE

10.0
mV

100.0
mV

Last Standardization : 19 Jul 2004 / 10:15:04 PM
 Current Ion Method : Analate Subtraction

> Touch AS to take 1st reading using ANALATE SUBTRACTION
 > Touch standardize icon to access standardization mode

Show Graph

Sample ID : 11	Temp. :25.0 C(Default)
User ID : Default	mV :65.5
Ion Type : CAT+	Slope :103.5 %
Auto Read : OFF	Blank Ofs. :.....

Standardize
AS
AN SUB
Mode
Setup
Print
Log Data
Profile
Home
Logoff
Help

Ion Measurement(mV)
Channel 1

65.5

STABLE

Analate Subtraction Result

40.3

ppm

Calculated Slope : 61.0 mV
 Reading 1 : 84.0 mV
 Reading 2 : 65.4 mV
 Sample Volume : 10.0
 Standard Volume : 100.0
 ISA Volume : 10.0
 Standard Concentration : 10.0

OK
PRINT

Standardize
AS
AN SUB
Mode
Setup
Print
Log Data
Profile
Home
Logoff
Help

Ion Operation: Graphing Function

XL25, 50 and 60 meters

You can view your data as a real-time graph on screen to display ion concentration changes over time. The graph refreshes every hour from the start of graphing.

1. To view your data in graph format, touch **Show Graph**.
2. To start plotting data, touch **Start Plotting**. To stop plotting data, touch **Stop Plotting**.
Once the plotting is stopped, the displayed graph can be dragged left/right and up/down.
3. To view your data more closely, touch. **Zoom In**. To view more data at one time, touch **Zoom Out**.
4. To hide the graph, touch **Hide Graph**.

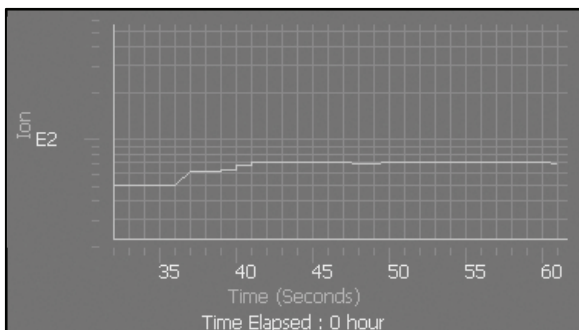

DO Operation

XL40 and 60 meters

The XL40 and XL60 meters allow you to measure DO, BOD, OUR and SOUR. Each mode is independent from one another and needs to be standardized separately. However the basic procedure for standardization is similar for each mode. This manual will focus on DO standardization.

Since each measurement mode differs there will be separate measurement sections for each: DO measure dissolved oxygen, BOD measures Biochemical Oxygen Demand, OUR measures Oxygen Uptake Rate and SOUR measures Specific Oxygen Uptake Rate. The DO and BOD mode can measure in % Saturation, mg/L or mbar (see Setup section to choose).

Before measuring DO, BOD, OUR or SOUR, you will need to standardize the meter using standards with known % Saturation or mg/L. This meter can perform a one- or two-point standardization. You will need to set your meter to one- or two-point calibration in the Setup mode for DO or BOD (OUR and SOUR can only calibrated at one point in mg/L). You also have to use the Setup mode set Auto or Manual calibration (available for all measuring modes). The % Saturation measuring units has the following options to set: Auto calibration and one point (100% saturation), Auto calibration and two point (0 and 100% saturation), and Manual calibration and one point (input by user). The mg/L measuring units has the following options to set: Auto calibration and one point (8.26 mg/L) and Manual calibration and one point (input by user). There are no calibration options for mbar measuring units.

The meter will continually monitor the DO (BOD, OUR or SOUR) reading in this mode and will not lock onto a single reading. However, once the reading has become stable, **STABLE** will be displayed (unless the Stable indicator has been turned **OFF** in the Setup mode). Remember to setup your measuring mode parameters; refer to DO Setup section for instructions.

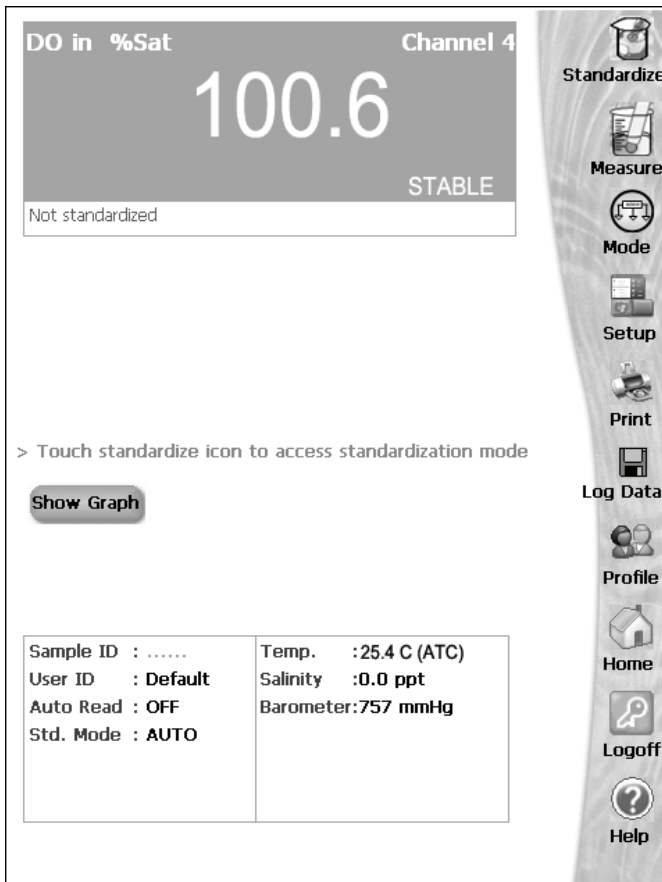

DO measure screen without standardization

DO Operation: Standardizing XL40 and 60 meters

The XL40 and XL60 meter has two standardization modes for % saturation and mg/L: automatic and manual. The factory setting is for a one point automatic standardization in % saturation. Refer to the setup section to choose measuring units, one or two point standardization, and automatic or manual standardization. There is no standardization for mbar measuring units.

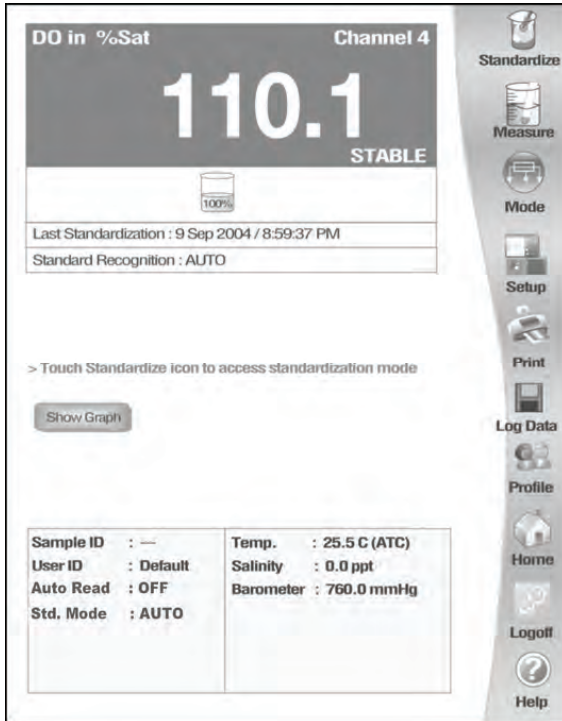

DO standardization with Auto standard recognition

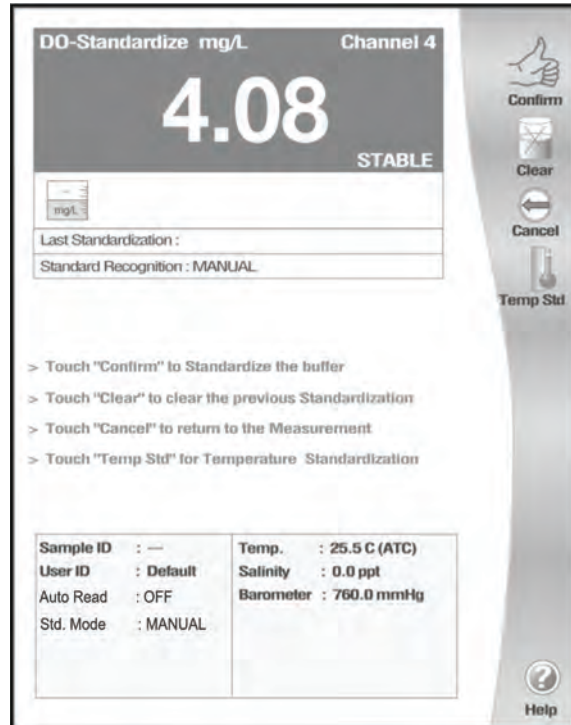

DO standardization with Manual standard recognition

Note: Allow the probe to warm up for 30 minutes after connecting it to the meter and prior to standardization.

DO Operation: Standardizing XL40 and 60 meters

Automatic standardization at one point—% Saturation

A one point automatic standardization for % saturation assumes the dissolved oxygen level is at saturation (100% at 760 mm Hg). The meter will accept readings between 30 and 200% saturation for standardization.

1. Touch **Standardize** on the DO measure screen to access the standardize screen.
2. If the screen says “**Not standardized**” proceed to step 4.
3. Touch **Clear** if you need to delete the previous standardization values
4. Insert DO probe into a BOD bottle filled with 1 inch of water to provide a 100% relative humidity environment.
5. Allow probe to stabilize for 30 minutes.
6. The screen will flash a 100% beaker icon. When the reading is stable, **STABLE** appears on the screen. Touch **Confirm** to standardize. The meter will then return to the DO measure screen.

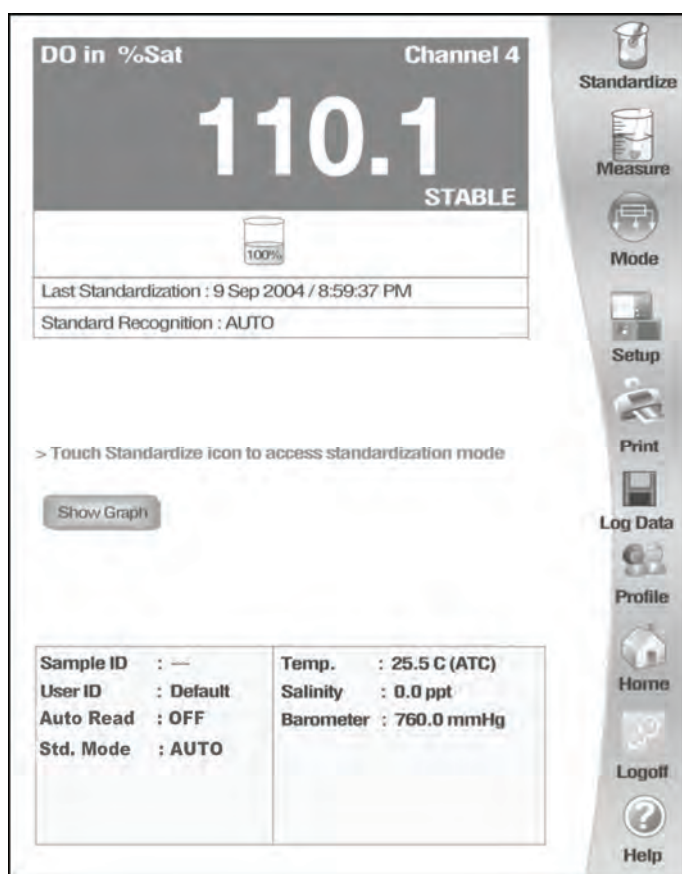

Once meter is calibrated DO Measure screen shows the standard, the time/date of last standardization and AUTO standard recognition.

It is important to prepare your DO probe according to the manufacturer's instructions prior to use.

DO Operation: Standardizing XL40 and 60 meters

Automatic standardization at two points—% Saturation

For this standardization, the 0% saturation must be the first point followed by 100% saturation. The meter will accept readings below 5% saturation for 0% saturation standardization and between 30 and 200% saturation for 100% saturation (at 760 mm Hg).

1. Touch **Standardize** on the DO measure screen to access the standardize screen.
2. If the screen says “**Not standardized**” proceed to step 4.
3. Touch **Clear** if you need to delete the previous standardization values.
4. Insert DO probe into a bottle containing 0% saturation solution.
5. Allow probe to stabilize for 30 minutes, constantly stirring the solution.
6. The screen will flash a 0% beaker icon. When the reading is stable, **STABLE** appears on the screen. Touch **Confirm** to standardize. The meter will then return to the DO measure screen.
7. Touch **Standardize** on the DO measure screen to access the standardize screen.
8. Insert DO probe into a BOD bottle filled with 1 inch of water to provide a 100% relative humidity environment.
9. Allow probe to stabilize for 30 minutes.
10. The screen will flash a 100% beaker icon next to the 0% beaker icon. When the reading is stable, **STABLE** appears on the screen. Touch **Confirm** to standardize. The meter will then return to the DO measure screen.

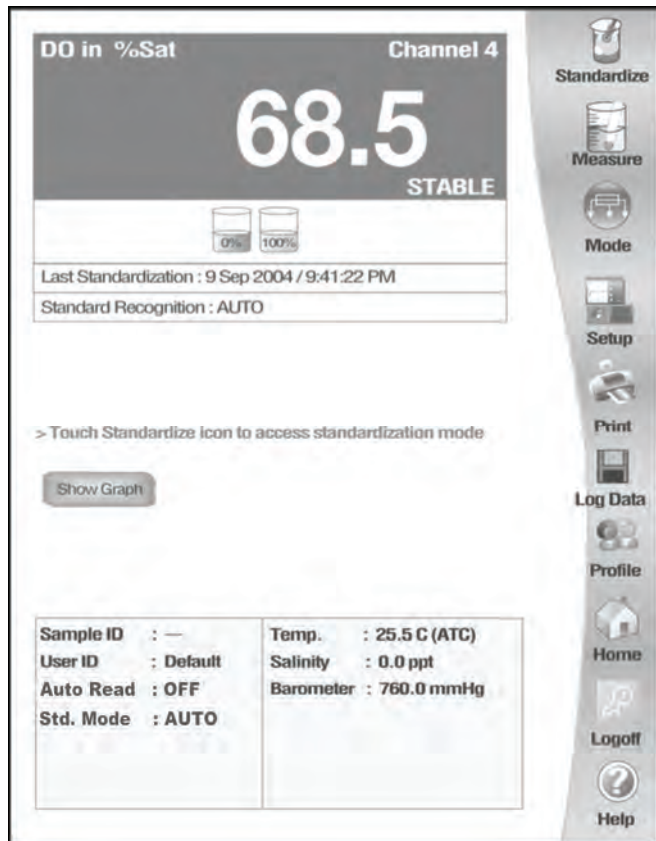

Once meter is calibrated DO Measure screen shows the standards, the time/date of last standardization and AUTO standard recognition.

DO Operation: Standardizing XL40 and 60 meters

Automatic standardization at one point—mg/L

A one point automatic standardization for mg/L assumes the dissolved oxygen level is at saturation (8.26 mg/L at 0 ppt salinity, 25.0 °C and 760 mmHg). The meter will accept readings $\pm 50\%$ of the standard value.

1. Touch **Standardize** on the DO measure screen to access the standardize screen.
2. If the screen says “**Not standardized**” proceed to step 4.
3. Touch **Clear** if you need to delete the previous standardization values
4. Insert DO probe into a BOD bottle filled with 1 inch of water to provide a 100% relative humidity environment.
5. Allow probe to stabilize for 30 minutes.
6. The screen will flash a 8.26 mg/L beaker icon. When the reading is stable, **STABLE** appears on the screen. Touch **Confirm** to standardize. The meter will then return to the DO measure screen.

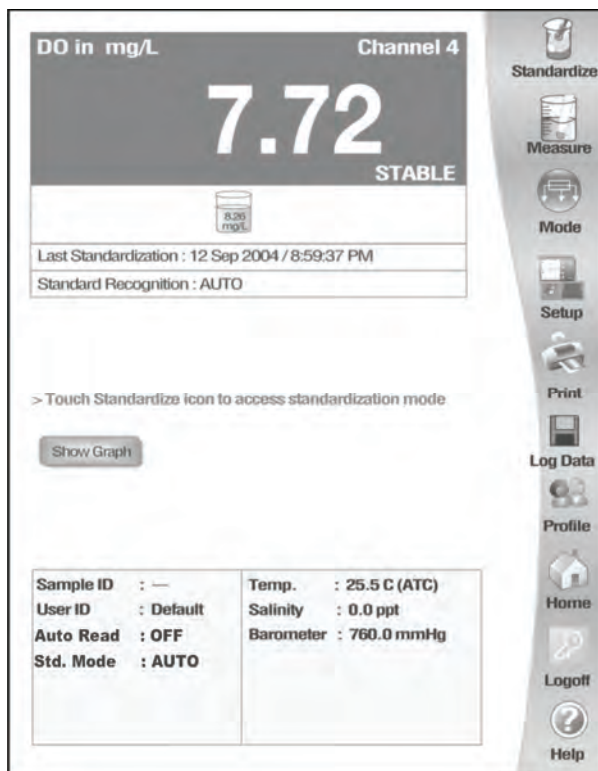

Once meter is calibrated DO Measure screen shows the standard, the time/date of last standardization and AUTO standard

Automatic standardization at two points—mg/L

For two point automatic standardization, the 0 mg/L must be the first standardization point followed by 8.26 mg/L (at 0 ppt salinity, 25.0 °C and 760 mmHg). The meter will accept readings below 1 mg/L for 0 mg/L standardization and $\pm 50\%$ of the next standard value.

1. Touch **Standardize** on the DO measure screen to access the standardize screen.
2. If the screen says “**Not standardized**” proceed to step 4.
3. Touch **Clear** if you need to delete the previous standardization values.
4. Insert DO probe into a bottle containing 0 mg/L solution.
5. Allow probe to stabilize for 30 minutes, constantly stirring the solution.
6. The screen will flash a 0mg/L beaker icon. When the reading is stable, **STABLE** appears on the screen. Touch **Confirm** to standardize. The meter will then return to the DO measure screen.
7. Touch **Standardize** on the DO measure screen to access the standardize screen.
8. Insert DO probe into a BOD bottle filled with 1 inch of water to provide a 100% relative humidity environment.
9. Allow probe to stabilize for 30 minutes.
10. The screen will flash a 8.26 mg/L beaker icon next to the 0 mg/L beaker icon. When the reading is stable, **STABLE** appears on the screen. Touch **Confirm** to standardize. The meter will then return to the DO measure screen.

DO Operation: Standardizing XL40 and 60 meters

Manual standardization at one point—both % Saturation and mg/L

A one point manual standardization for % saturation and mg/L allows user to key in the value to be used for standardization (at 760 mmHg). The meter will accept readings between $\pm 50\%$ of the value entered.

1. Touch **Standardize** on the DO measure screen to access the standardize screen.
2. If the screen says “**Not standardized**” proceed to step 4.
3. Touch **Clear** if you need to delete the previous standardization values
4. Insert DO probe into a BOD bottle filled with a solution of known saturation.
5. Allow probe to stabilize for 30 minutes, constantly stirring the solution.
6. The screen will flash a blank beaker icon for a few seconds, then a numeric keypad appears. Use the alphanumeric keypad on the screen to enter desired value. The **BS** key allows you to remove characters that are incorrectly entered.
7. Touch **Enter** on the keypad to accept the value and return to the DO standardization screen.
8. The screen will flash a beaker icon with the entered value. When the reading is stable, **STABLE** appears on the screen. Touch Confirm to standardize. The meter will then return to the DO measure screen.

It is important to prepare your DO probe according to the manufacturer's instructions prior to use.

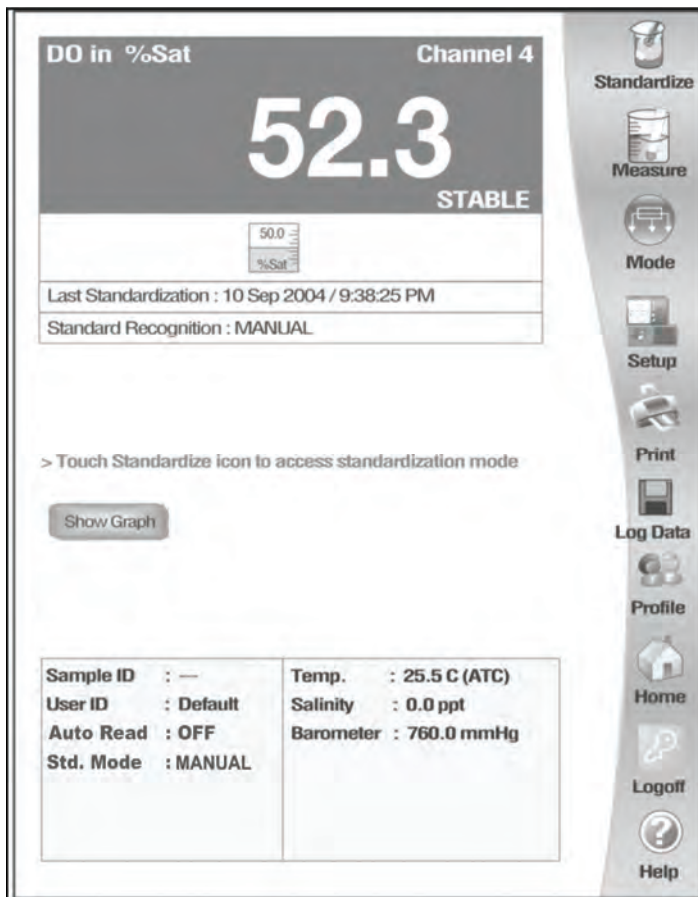

Once meter is calibrated DO Measure screen shows the standard, the time/date of last standardization and MANUAL standard recognition.

DO Operation: Temperature Standardization

XL40 and 60 meters

To Standardize Temperature of the Meter

1. Touch **Standardize** on the DO measure screen to access the standardized screen.
2. Make sure DO probe with built ATC is attached to meter.
3. Immerse your DO probe with built ATC probe into a solution of known temperature, such as a temperature bath, for a few minutes while temperature stabilizes.
4. Touch **Temp Std** to access temperature standardization.
5. The Temperature Standardization screen appears. Check the current temperature displayed with that of the solution of known temperature. Touch the **Standardization Temperature** box and use numeric keypad to enter the current temperature. Press **Enter** to confirm value.
6. Touch **OK** to confirm Standardization Temperature and return to the DO Measure screen. Touch **Reset** to reset and enter a new standardization temperature. Touch **Cancel** to cancel temperature standardization and return to the DO Standardization screen.

Note: The meter will not allow entered value to exceed $\pm 5^{\circ}\text{C}$ of the ATC probe value. If entered value exceeds $\pm 5^{\circ}\text{C}$ an error window will appear and you will have to re-enter value or cancel out of the temperature screen. This might indicate that you have a faulty ATC probe.

Temperature Standardization

Current Temperature C F K

Standardization Temperature C F K

OK Cancel Reset

DO Operation: BOD Measurement

XL40 and 60 meters

The measurement mode is used to measure Dissolved Oxygen (DO) in %Sat, mg/L or mbar. The DO measure screen provides a readout from the DO probe attached to the meter. Before measuring DO, you will need to standardize your probe: see '**DO Operation: Standardizing**' section for details. It is good practice to standardize the probe daily for best results.

If the Auto Read is active, the meter will lock (freeze) onto a reading when it is stable. The meter will not change from this reading until the Measure button is pushed, at which time a new reading is taken. If the Auto Read is not active, the meter will continuously monitor the DO and the reading will indicate any change in the DO level. If the **STABLE** indicator is turned on, the **STABLE** indicator appears on the screen when the reading meets the chosen stability criteria.

NOTE: Prior to sample measurement, verify the salinity of the sample and enter that salinity value using the setup menu (see '**DO Setup: Set Salinity / Set Alarm Limits**' section for details).

To Measure DO with Auto Read ON

1. Immerse rinsed DO probe into the sample solution, constantly stirring the solution.
2. Touch **Measure**.
3. The meter will continuously measure the sample until the stability criteria is met. At this time the reading will freeze and the **STABLE*** indicator appears.
4. Record the reading once the measurement has become stable.
5. To take another reading, repeat steps 1 to 4.

* Please note that **STABLE** will only appear if you have completed a successful two point calibration.

To Measure DO with Auto Read OFF

1. Immerse rinsed DO probe into the sample solution, constantly stirring the solution.
2. The meter will continuously measure the sample until the stability criteria is met. At this time the **STABLE** indicator appears.
3. Record the reading once the measurement has become stable.
4. To take another reading, repeat steps 1 to 3.

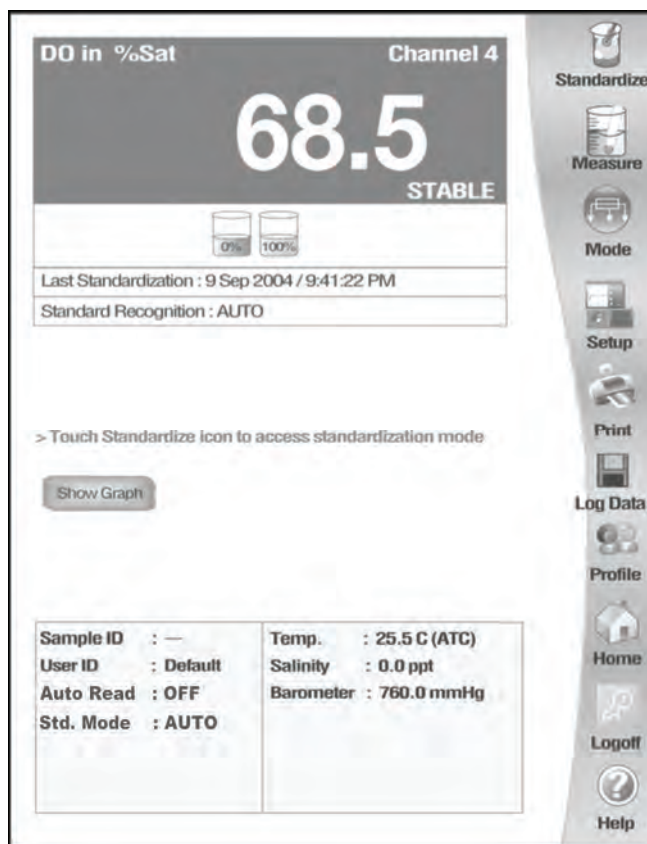

NOTES: You can access other functions of the meter with the remaining buttons on the measure screen.

- Touching **Setup** will access the Setup screen.
- At anytime, you can touch **Mode** to access another mode of operation including: BOD, OUR and SOUR.

DO Operation: BOD Measurement

XL40 and 60 meters

To measure BOD, a sample is seeded and incubated in the dark at 20°C for five days. The dissolved oxygen concentration is then measured and subtracted from the initial, pre-incubation dissolved oxygen concentration. The difference is a measure of the Biochemical Oxygen Demand (BOD) of the sample.

Before measuring BOD, remember to setup your BOD measuring mode parameter from the BOD Setup screen. Once the meter is standardized you are ready to measure DO for a BOD measurement.



BOD Measure screen with STABLE indicator ON

DO Operation: BOD Measurement

XL40 and 60 meters

BOD Calculation Parameters

The Calculation parameter screen requires you to enter information regarding the current sample or seed. The meter comes set to default values to measure for sample reading and to set it to measure for a seed reading the Seed button should be pressed.

The Current Reading text box will show the current DO measurement of the sample or seed. The Bottle ID text box allows you to enter the bottle ID of the sample or seed for a new reading for the selection of Add new Sample/Seed option from the scroll selection.

To Enter BOD Calculation Parameter Screen

1. Touch **BOD** on the BOD measurement screen.
2. You are now in the BOD Calculation Parameter Screen. See **To measure BOD of the Sample** and **To measure BOD of the Seed** for instructions.

The screenshot shows the BOD Calculation Parameter Screen. At the top, there are two buttons for 'Sample Type': 'SAMPLE' and 'SEED'. To the right, the 'Current Reading' is displayed as 17.56. Below these, there is a 'Bottle ID' text box and a dropdown menu labeled 'Add new Sample/Seed'. A large, rounded button labeled 'Apply BOD Detail' is centered on the screen. Below this button is a large, empty rectangular area labeled 'Available Sample ID'. At the bottom of the screen, there are five buttons: 'Select View', 'View Result', 'Exit', 'Delete All Sample Detail', and 'Help'.

Button Function for BOD Calculation Parameter Screen

Touch **Select View** to go to view option selection screen.

Touch **View Result** to go to the BOD measurement result screen.

Touch **Exit** to go back to the BOD measurement screen without saving any changed data in the BOD Calculation Parameter Screen.

Touch **Delete All Sample Detail** to delete all stored sample or seed measurements for BOD.

When you touch the **Help** button, information about the current screen appears. This information includes step-by-step instructions for operating the meter from the current screen and possible applications information for that screen.

DO Operation: BOD Measurement XL40 and 60 meters

Sample Type Current Reading

Select Existing ID

Bottle ID

Description

Bottle Volume ml

Seed Volume ml

Sample Volume ml

Predilution factor (1 to X)

Available Sample ID

To measure BOD of the Sample:

3. Insert DO probe into a BOD bottle filled with your sample.
4. Allow probe to stabilize for 30 minutes, constantly stirring the solution.
5. Touch **BOD** on the BOD measurement screen to enter BOD Calculation Parameter Screen. Screen show current DO reading.

Sample Type Current Reading

6. Touch the **SAMPLE** to designate BOD measurement as sample.

DO Operation: BOD Measurement

XL40 and 60 meters

Initial DO measurement for Sample BOD calculation

The Bottle ID text entry box allows you to enter the bottle ID of the sample for new reading. The **Select Existing ID** scroll box is in the selection of **Add new sample/Seed** option for new sample reading.



The screenshot shows a text entry box for 'Bottle ID' containing the number '1'. To its right is a dropdown menu labeled 'Add new Sample/Seed' with a downward arrow. Above the dropdown is the text 'Select Existing ID'.

To enter Bottle ID:

1. Touch the **Bottle ID** box.
2. Use the alphanumeric keypad to enter the desired Bottle ID. The **BS** key allows you to remove characters that are incorrectly entered.
3. Touch **Enter** to accept current Bottle ID and return to the BOD Calculation Parameter Screen.
4. After entering the Bottle ID, the following text entry boxes will appear and require more information regarding the current sample:
 - a. Description
 - b. Sample Volume
 - c. Seed Volume
 - d. Bottle Volume
 - e. Pre-dilution factor only for sample)
5. After entering the above parameters for a new sample reading, touch **Apply BOD Detail** button to accept the initial reading for a sample used to calculate BOD.

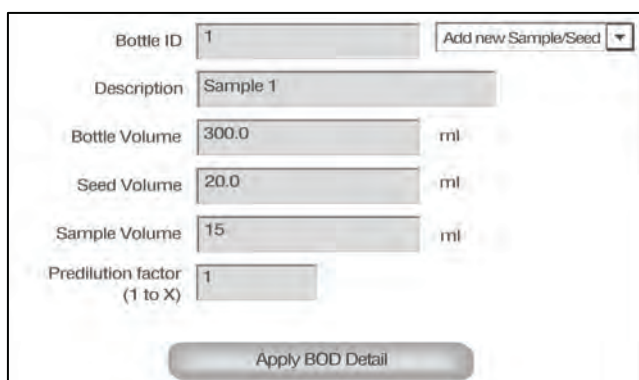

The screenshot displays the BOD Calculation Parameter Screen. It features several text entry boxes: 'Bottle ID' (1), 'Description' (Sample 1), 'Bottle Volume' (300.0 ml), 'Seed Volume' (20.0 ml), 'Sample Volume' (15 ml), and 'Predilution factor (1 to X)' (1). An 'Apply BOD Detail' button is located at the bottom. A dropdown menu 'Add new Sample/Seed' is visible at the top right.

NOTE: The stored data is displayed in the **Available Sample ID** text box in tree view. By selecting the + sign for a particular Bottle ID, all the stored parameters for that particular Bottle ID will display in the **Available Sample ID** text box. Select the - sign to close the tree view of the sample.

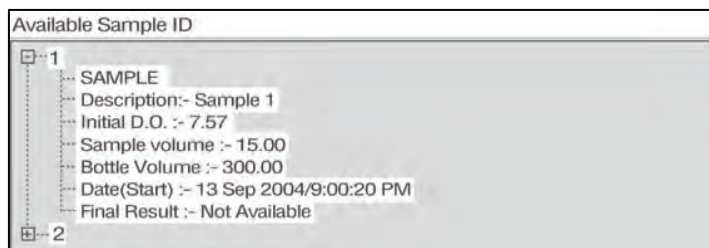

The screenshot shows the 'Available Sample ID' tree view. It lists two samples, 1 and 2. Sample 1 is expanded, showing the following details: Description:- Sample 1, Initial D.O. :- 7.57, Sample volume :- 15.00, Bottle Volume :- 300.00, Date(Start) :- 13 Sep 2004/9:00:20 PM, and Final Result :- Not Available.

DO Operation: BOD Measurement

XL40 and 60 meters

To measure BOD of the Seed:

1. Insert DO probe into a BOD bottle filled with your seed.
2. Allow probe to stabilize for 30 minutes, constantly stirring the solution.
3. Touch **BOD** on the BOD measurement screen to enter BOD Calculation Parameter Screen. Screen show current DO reading.

Sample Type: SAMPLE, SEED
Current Reading: 6.80
Select Existing ID

4. Touch the **SEED** to designate BOD measurement as seed.

Initial DO measurement for Seed BOD calculation

The Bottle ID text entry box allows you to enter the bottle ID of the sample for new reading. The **Select Existing ID** scroll box is in the selection of **Add new sample/Seed** option for new seed reading.

Bottle ID: 3
Add new Sample/Seed

To enter Bottle ID:

1. Touch the **Bottle ID** box.
2. Use the alphanumeric keypad to enter the desired Bottle ID. The **BS** key allows you to remove characters that are incorrectly entered.
3. Touch **Enter** to accept current Bottle ID and return to the BOD Calculation Parameter Screen.
4. After entering the Bottle ID, the following text entry boxes will appear and require more information regarding the current sample:
 - a. Description
 - b. Seed Volume
 - c. Bottle Volume

Bottle ID: 3
Description: Seed 1
Bottle Volume: 300.0 ml
Seed Volume: 30.0 ml
Apply BOD Detail

After entering the above parameters for a new sample reading, touch **Apply BOD Detail** button to accept the initial reading for a seed used to calculate BOD.

NOTE: The stored data is displayed in the **Available Sample ID** text box in tree view. By selecting the + sign for a particular Bottle ID, all the stored parameters for that particular Bottle ID will display in the **Available Sample ID** text box. Select the - sign to close the tree view of the sample.

Available Sample ID

- 1 SAMPLE
 - Description:- Sample 1
 - Initial D.O. :- 7.57
 - Sample volume :- 15.00
 - Bottle Volume :- 300.00
 - Date(Start) :- 13 Sep 2004/9:00:20 PM
 - Final Result :- Not Available
- 2

DO Operation: BOD Measurement

XL40 and 60 meters

Final DO measurement for Sample BOD calculation:

1. To take the final reading for BOD measurement, access the **Select Existing ID** scroll box and select the Bottle ID that you are going to take final DO reading for the BOD calculation.
2. The initial reading and the BOD calculation parameters for that particular sample Bottle ID display in the **Available sample ID** text box.
3. Touch the **Calculate Final BOD** button to accept the current DO reading as a final reading for BOD calculation.



If the following parameters match, BOD result will be shown in the screen.

1. At least one day has passed after taking the initial reading that is stored in the memory for that particular bottle ID. If not, user will be prompted with message box for taking this reading as repetitive initial reading. **AND 2)** The final DO reading and DO loss (Difference between the Initial DO reading and final DO reading) must meet the criteria for sample that set under the Set BOD configuration option in Setup mode. This condition is only used when calculating the average BOD value. If this condition is not met, then average BOD will be zero.

The Average BOD values calculated using the calculated BOD value for the samples taken on the same date with the same description. All seed values on this date will be used to calculate the seed correction value used in all subsequent samples. Therefore it is necessary to run seed samples on the same day as the BOD samples. Seed data will be used only if the SEED DO loss (Difference between the Initial seed DO reading and final seed DO reading) and the final DO exceed the criteria for seed that is set under the **Set BOD configuration** option in Setup mode.

For a same bottle ID, if subsequent sample value is taken after BOD calculation is done, a message box will pop up and verify that **Repeat the final reading?** for the BOD measurement. Touch **OK** to do so and overwrite the final measurement. Touch **Quit** to return to the BOD measurement screen.

DO Operation: BOD Measurement

XL40 and 60 meters

Final DO measurement for Seed BOD calculation:

1. To take the final reading for BOD measurement, access the **Select Existing ID** scroll box and select the Bottle ID that you are going to take final DO reading for the BOD calculation.
2. The initial reading and the BOD calculation parameters for that particular sample Bottle ID display in the **Available sample ID** text box.
3. Touch the **Calculate Final BOD** button to accept the current DO reading as a final reading for BOD calculation.



If the following parameters match, BOD result will be shown in the screen.

1. At least one day has passed after taking the initial reading that is stored in the memory for that particular bottle ID. If not, user will be prompted with message box for taking this reading as repetitive initial reading. **AND 2)** The final DO reading and DO loss (Difference between the Initial DO reading and final DO reading) must meet the criteria for sample that set under the **Set BOD configuration** option in Setup mode. This condition is only used when calculating the average BOD value. If this condition is not met, then average BOD will be zero.

The Average BOD value is calculated by using the calculated BOD value for the seeds taken on the same date with the same description. All seed values on this date will be used to calculate the seed correction value used in all subsequent samples. Therefore it is necessary to run seed samples on the same day as the BOD samples. Seed data will be used only if the SEED DO loss (Difference between the Initial seed DO reading and final seed DO reading) and the final DO exceed the criteria for seed that is set under the **Set BOD configuration** option in Setup mode.

For a same bottle ID, if subsequent sample value is taken after BOD calculation is done, a message box will pop up and verify that **Repeat the final reading?** for the BOD measurement. Touch **OK** to do so and overwrite the final measurement. Touch **Quit** to return to the BOD measurement screen.

DO Operation: BOD Measurement

XL40 and 60 meters

The **Select View Screen** allows for single or multiple Bottle ID selection for the result view screen.

The **Available Bottle ID** text box lists all available Bottle ID stored in the meter for BOD measurement. The following options are available for selection and de-selection:

1. Touch > button for single Bottle ID selection.
2. Touch < button for single Bottle ID de-selection.
3. Touch >> button for all available bottle IDs selection.
4. Touch << button for all available bottle IDs de-selection from all selected Bottle ID.

The selected Bottle ID text box will list all the selected Bottle IDs from the available ID from the result view.

Button Functions

Touch **OK** for accepting this selection for result view.

The **Help** button allows you to access helpful information on any screen. When you touch the **Help** button, information about the current screen appears. This information will include step-by-step instructions for operating the meter from the current screen and possible applications information for that screen.

Touch **Cancel** button to go back to the measurement screen without consider the selection on this screen.

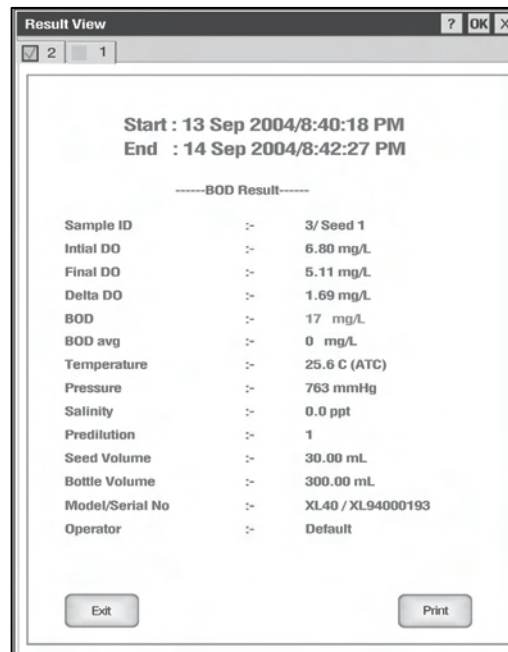
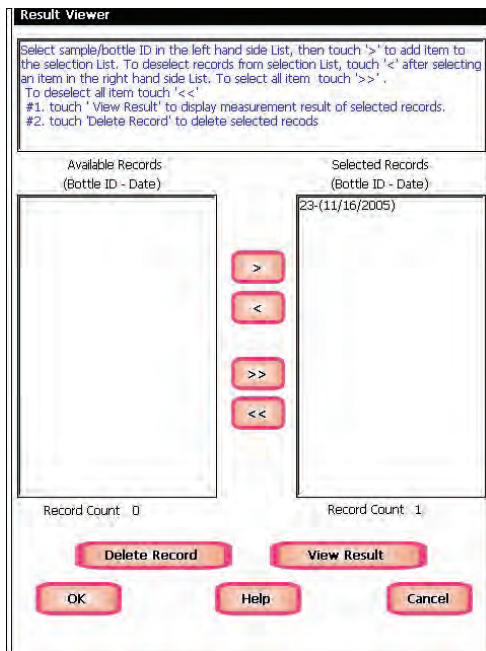

BOD Result View Screen

DO Operation: OUR Measurement

XL40 and 60 meters

This mode is used to measure Oxygen Uptake Rate (OUR). The OUR is used to determine the oxygen consumption or respiration rate, is defined as the milligram of oxygen consumed per hour. Remember to setup your OUR measuring mode parameters from the OUR Setup screen.

To Take OUR Measurements

1. Touch **OUR Start** icon to begin OUR measurement.
2. The screen will indicate the test is in progress with **RUNNING** and a timer on the main screen (the time the test is run is setup in the OUR Setup option, see page 38). The OUR value in mg/L/hr and the DO reading appears as mg/L.

3. To end the OUR test, touch **Stop OUR** icon or let the timer expire.

If you touch the **Stop OUR** icon before the timer expires, you will get a message indicating your measurement reading might not be accurate.

If you let the timer expire, the message states the measurement has been stopped

4. Touch **OK** to confirm either message.
5. Another dialog box appears asking if you wish to save current OUR result. Touch **OK** to save or **Cancel** to erase and return to OUR measurement screen.
6. If you touched **OK**, a new dialog box appears to ask if you want to view the results. Touch **OK** to proceed to the **Result View** screen showing OUR value and other important test details.
7. Touch **Exit** to exit Result View screen and return to OUR measurement screen. Touch **Delete All** to delete all OUR test results in memory. OR Touch **Print** to send the OUR test results to a computer or printer.



OUR measurement in progress

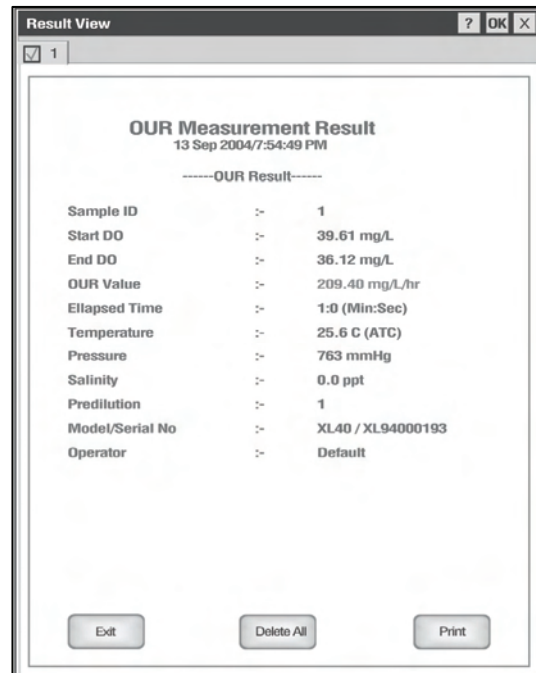

OUR Measurement View Result Screen

DO Operation: SOUR Measurement

XL40 and 60 meters

This mode is used to measure Specific Oxygen Uptake Rate (SOUR). The SOUR is used to determine the oxygen consumption or respiration rate, is known as the milligram of oxygen consumed per gram of volatile suspended solids per hour. Remember to setup your SOUR measuring mode parameter from the SOUR Setup screen.

To Take SOUR Measurements

1. Touch **SOUR Start** icon to begin SOUR measurement.
2. The screen will indicate the test is in progress with **RUNNING** and a timer on the main screen (the time the test is run is setup in the SOUR Setup option, see page 76). The SOUR value in mg/hr/g and the DO reading appears as mg/L.
3. To end the SOUR test, touch **Stop SOUR** icon or let the timer expire.
If you touch the **Stop SOUR** icon before the timer expires, you will get a message indicating your measurement reading might not be accurate.
If you let the timer expire, the message states the measurement has been stopped.
4. Touch **OK** to confirm either message.
5. Another dialog box appears asking if you wish to save current SOUR result. Touch **OK** to save or **Cancel** to erase and return to SOUR measurement screen.
6. If you touched **OK**, a new dialog box appears to ask if you want to view the results. Touch **OK** to proceed to the **Result View** screen showing SOUR value and other important test details.
7. Touch **Exit** to exit Result View screen and return to SOUR measurement screen.
Touch **Delete All** to delete all SOUR test results in memory. OR Touch **Print** to send the SOUR test results to a computer or printer.

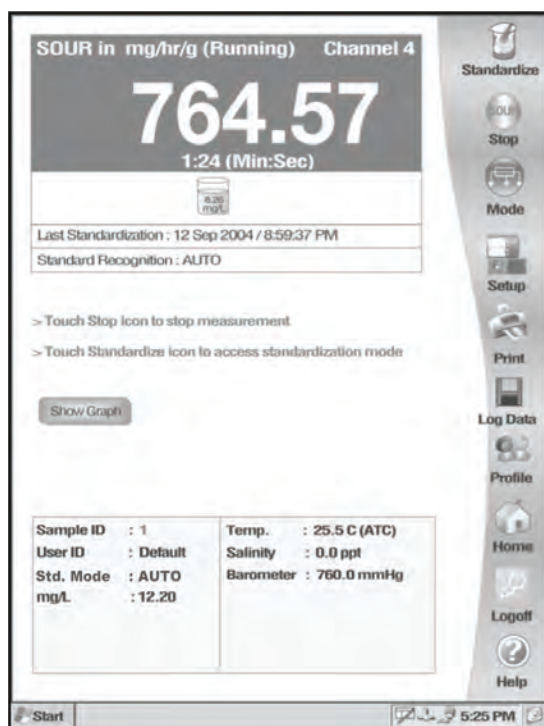

SOUR measurement in progress.

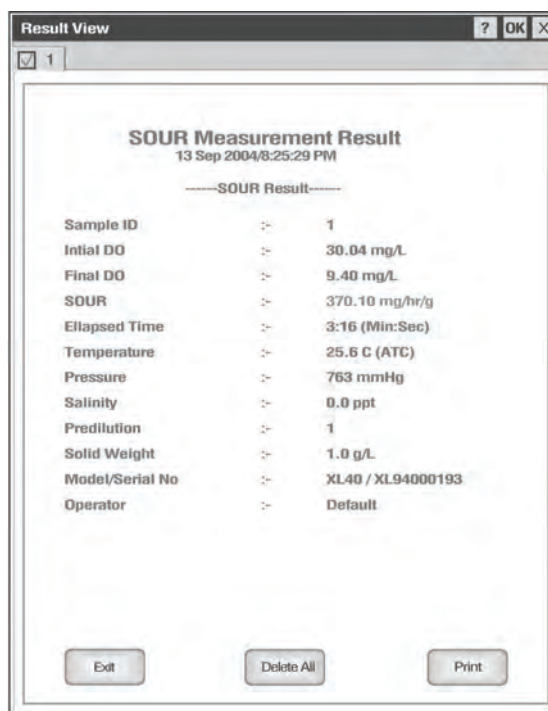

SOUR Measurement View Result Screen

DO Operation: Graphing Function

XL40 and 60 meters

You can view your data as a real-time graph on screen to display ion concentration changes over time. The graph refreshes every hour from the start of graphing.

1. To view your data in graph format, touch **Show Graph**.
2. To start plotting data, touch **Start Plotting**. To stop plotting data, touch **Stop Plotting**.
Once the plotting is stopped, the displayed graph can be dragged left/right and up/down.
3. To view your data more closely, touch. **Zoom In**. To view more data at one time, touch **Zoom Out**.

To hide the graph, touch **Hide Graph**.

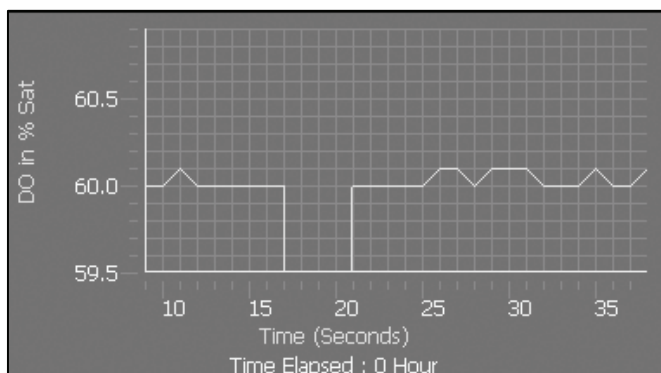

Conductivity Operation: About Conductivity Measurement

XL20, 30, 50 and 60 meters

The XL20, XL30, XL50, XL60 meters allows you to measure conductivity, resistivity, TDS (total dissolved solids) and salinity. Each mode is independent from one another and needs to be standardized separately. However the basic procedure for standardization and measurement is similar for each mode. This manual will focus on conductivity standardization and measurement with the variations for other modes noted. Each measuring mode has four measuring ranges.

Conductivity: 0 to 200.0 μS , 200.0 μS to 2.000 mS, 2.000 to 20.00 mS, and 20.00 to 500.0 mS.

Resistivity: 0 to 20.00 KOhms, 20.00 to 200.0 KOhms, 200.0 KOhms to 2.000 MOhms, and 2.000 to 100.0 MOhms.

TDS: 0 to 200.0 x TDS factor ppm, 200.0 x TDS factor to 2000 x TDS factor ppm, 2.000 x TDS factor to 20.00 x TDS factor ppt, and 20.00 x TDS factor to 200.0 x TDS factor ppt.

Salinity: 0 to 0.094 ppt, 0.094 to 1.000 ppt, 1.000 to 11.50 ppt, and 11.50 to 90.00 ppt

Before measuring conductivity, resistivity, TDS or salinity, you will need to standardize the meter using standards with known conductivity, resistivity, TDS or salinity values. This meter can perform a single- or multi-point standardization. You will need to set your meter to single- or multi-point calibration in the Setup mode for conductivity, resistivity, TDS or salinity. You may also use the Setup mode set conductivity to auto standard recognition to recognize preset values (84 μS , 1.413 mS, 12.88 mS and 111.8 mS).

The meter will continually monitor the conductivity (resistivity, TDS or salinity) reading in this mode and will not lock onto a single reading. However, once the reading has become stable, **STABLE** will be displayed (unless the Stable indicator has been turned OFF in the Setup mode). Remember to setup your measuring mode parameters. Refer to the setup section for the particular mode you will be measuring.

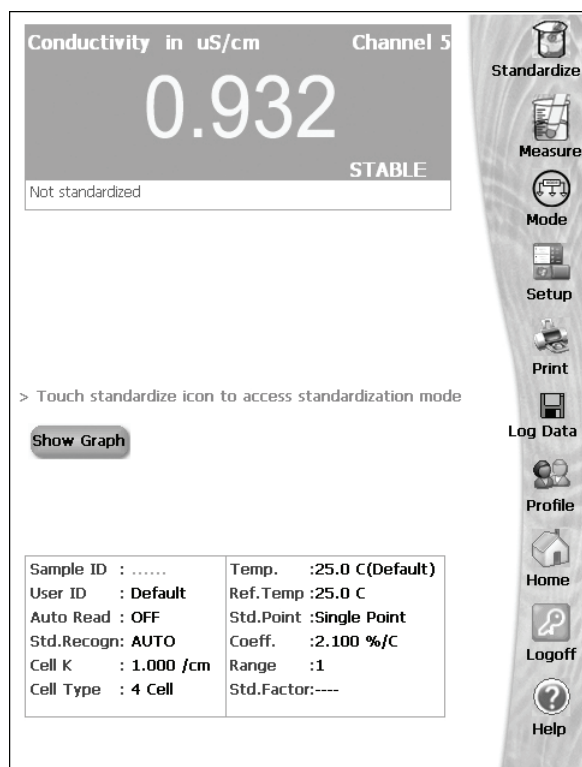

Conductivity measure screen without standardization

Conductivity Operation: Standardizing

XL20, 30, 50 and 60 meters

To Standardize the meter with Auto Standard Recognition (Conductivity mode only)

1. Touch **Standardize** on the conductivity measure screen to access the standardize screen.
2. If the screen says “Not standardized” proceed to step 4.
3. Touch **Clear** if you need to delete the previous standardization values
4. Immerse your rinsed conductivity cell in a standard solution (84 uS, 1.413 ms, 12.88 mS or 111.8 mS) and stir gently. The immersion depth should be enough to cover the vent holes on the electrode.
5. The screen will flash a beaker icon of the standard solution you have selected. When the reading is stable, **STABLE** appears on the screen. Touch **Confirm** to standardize the buffer. The meter will then return to the conductivity measure screen.
6. If you selected **Single Point** in the Setup mode Calibration Point(s), your meter is now ready to measure conductivity with one standardization factor.

OR

If you selected **Multi Point** in the Setup mode Calibration Point(s), touch **Standardize** on the conductivity measure screen to access the standardization screen and repeat steps 4 through 6 to standardize with up to 4 points. Performing a multi point calibration will give your meter multiple standardization factors.

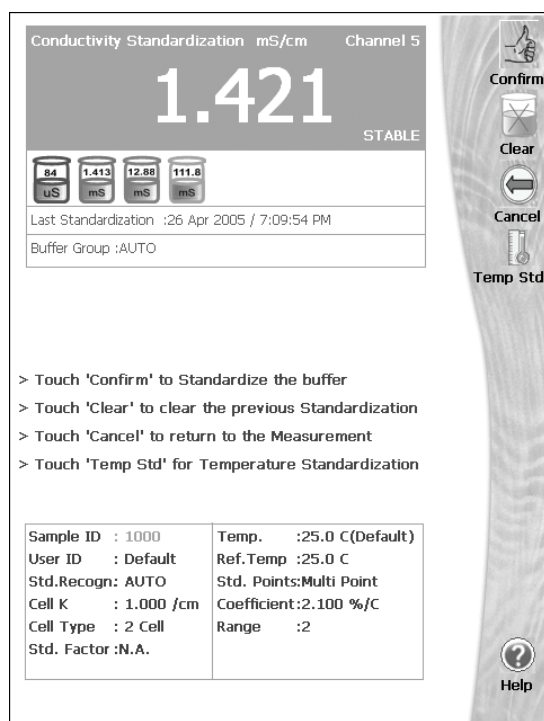

Conductivity standardization with Auto standard recognition (available in Conductivity Mode only)

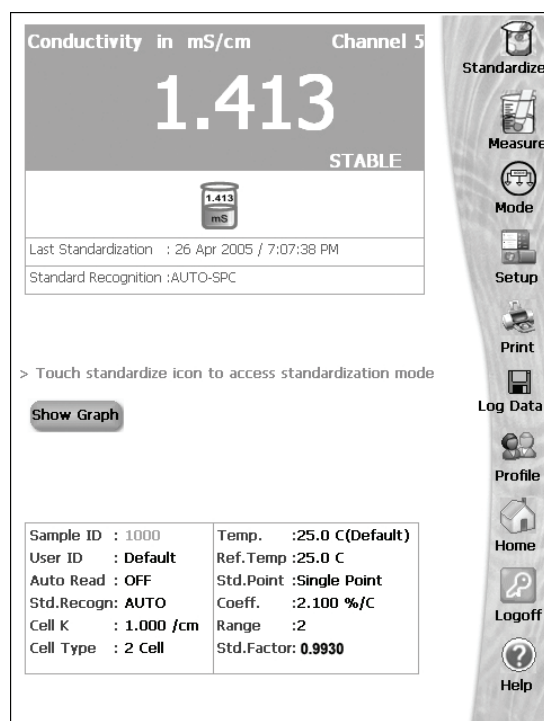

Once meter is calibrated, the conductivity Measure screen shows the standards and the time/date of last standardization.

Conductivity Operation: Standardizing

XL20, 30, 50 and 60 meters

To standardize the meter with Manual Standard Recognition (available in all modes)

1. Touch **Standardize** on the conductivity measure screen to access the standardized screen.
2. If the screen says “Not standardized” proceed to step 4.
3. Touch **Clear** if you need to delete the the previous standardization values.
4. Immerse your rinsed conductivity cell in a standard solution and stir gently. The immersion depth should be enough to cover the vent holes on the electrode.
5. The screen will flash each beaker icon once, then a number keypad will appear. Using the displayed keypad input the value of the standard that you are using to standardize the meter and then touch **Enter**. The meter now shows the standard value in the flashing beaker.
6. When the reading is stable, **STABLE** appears on the screen. Touch **Confirm** to standardize the buffer. The meter will then return to the conductivity measure screen.
7. If you selected **Single Point** in the Setup mode Calibration Point(s), your meter is now ready to measure conductivity with one standardization factor.

It is important to condition your conductivity probe according to the manufacturer's instructions prior to use.

OR

If you selected **Multi Point** in the Setup mode Calibration Point(s), touch **Standardize** on the conductivity measure screen to access the standardization screen and repeat steps 4 through 7 to standardize with up to 4 points. Performing a multi point calibration will give your meter multiple standardization factors.

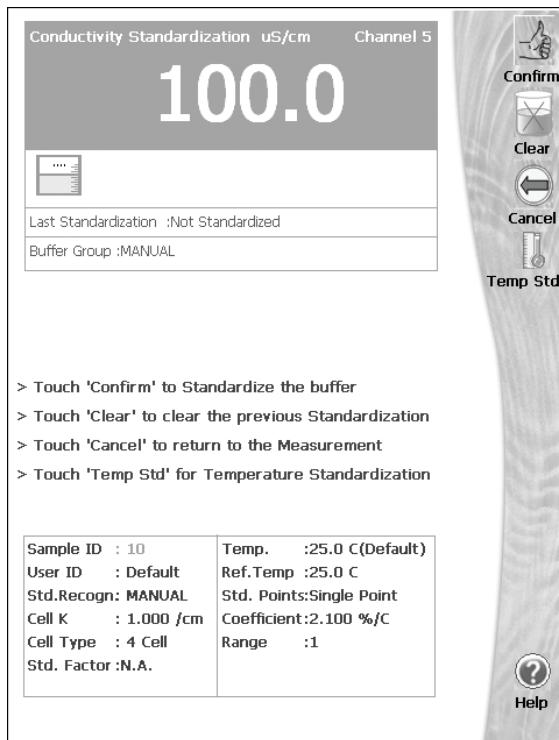

Conductivity standardization with Manual standard recognition

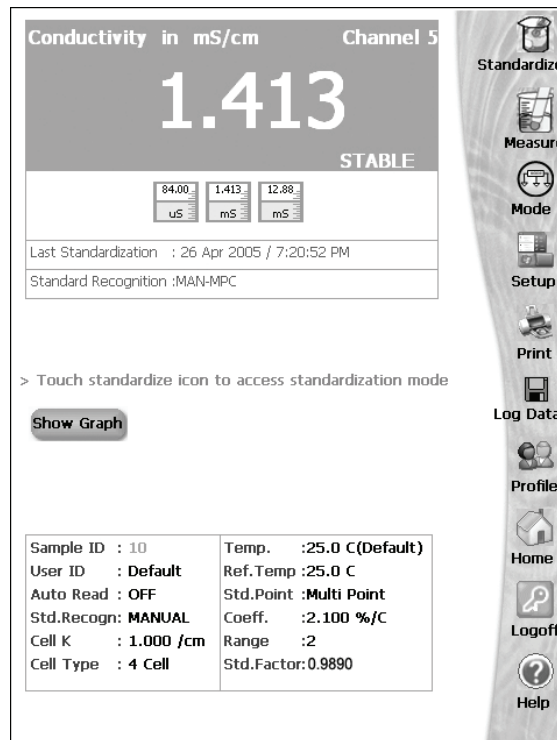

Once meter is calibrated, the conductivity Measure screen shows the standards and the time/date of last standardization.

Conductivity Operation: Temperature Standardization

XL20, 30, 50 and 60 meters

To Standardize Temperature of the Meter

1. Touch **Standardize** on the conductivity measure screen to access the standardized screen.
2. Make sure conductivity cell with built ATC is attached to meter.
3. Immerse your conductivity cell with built ATC probe into a solution of known temperature, such as a temperature bath, for a few minutes while temperature stabilizes.
4. Touch **Temp Std** to access temperature standardization
5. The Temperature Standardization screen appears. Check the current temperature displayed with that of the solution of known temperature. Touch the **Standardization Temperature** box and use numeric keypad to enter the current temperature. Press **Enter** to confirm value.
6. Touch **OK** to confirm Standardization Temperature and return to the conductivity Measure screen. Touch **Reset** to reset and enter a new standardization temperature. Touch **Cancel** to cancel temperature standardization and return to the conductivity Standardization screen.

Note: The meter will not allow entered value to exceed $\pm 5^{\circ}\text{C}$ of the ATC probe value. If entered value exceeds $\pm 5^{\circ}\text{C}$ an error window will appear and you will have to re-enter value or cancel out of the temperature screen. This might indicate that you have a faulty ATC probe.

Temperature Standardization

Current Temperature

Standardization Temperature

Conductivity Operation: Measurement

XL20, 30, 50 and 60 meters

Once the meter is standardized, you are ready to take conductivity, resistivity, TDS or salinity measurements of your sample.

1. Immerse the rinsed conductivity cell with built in ATC into the sample solution. The immersion depth should be enough to cover the vent holes on the electrode.
2. Stir the solution with the electrode briefly and then let the electrode sit still in the solution.
3. Record the reading once the measurement has become stable. STABLE will appear once the meter recognizes that the measurement is stable. The meter will automatically change ranges from $\mu\text{S}/\text{cm}$ to mS/cm as required.

NOTES: You can access other functions of the meter with the remaining buttons on the measure screen.

- Touch **Print** to send the data to a printer, or touch Log Data to log the data to memory (if a sample ID# has been assigned).
- Touching **Setup** will access the conductivity Setup screen.
- At anytime, you can touch **Mode** to access another mode of operation including: resistivity, TDS, salinity or the setup mode.

Conductivity in mS/cm Channel 5

1.413

STABLE

Last Standardization : 26 Apr 2005 / 7:07:38 PM

Standard Recognition : AUTO-SPC

> Touch standardize icon to access standardization mode

Show Graph

Sample ID : 10	Temp. : 25.0 C(Default)
User ID : Default	Ref.Temp : 25.0 C
Auto Read : OFF	Std.Point : Single Point
Std.Recogn: AUTO	Coeff. : 2.100 %/C
Cell K : 1.000 /cm	Range : 2
Cell Type : 2 Cell	Std.Factor: 0.9944

Standardize
Measure
Mode
Setup
Print
Log Data
Profile
Home
Logoff
Help

Conductivity Measure screen with STABLE indicator ON

Conductivity Operation: Graphic Function

XL20, 30, 50 and 60 meters

You can view your data as a real-time graph on screen to display conductivity changes over time. Time is plotted in seconds. The graph refreshes every hour from the start of graphing.

1. To view your data in graph format, touch **Show Graph**.
2. To start plotting data, touch **Start Plotting**. To stop plotting data, touch **Stop Plotting**.
Once the plotting is stopped, the displayed graph can be dragged left/right and up/down.
3. To view your data more closely, touch. **Zoom In**. To view more data at one time, touch **Zoom Out**.
4. To hide the graph, touch **Hide Graph**.

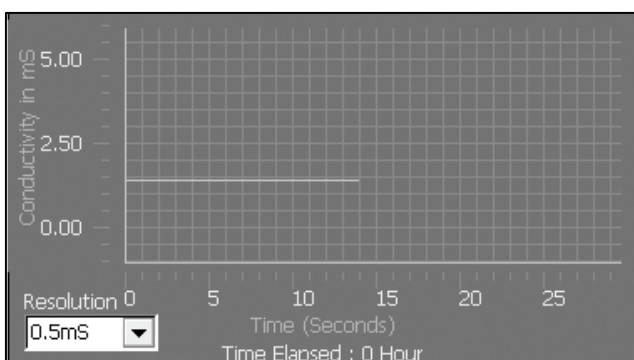
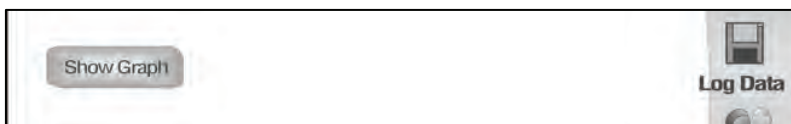

Warranty / Compliance

Meter, Electrode and Probe Warranty Statement

The Fisher Scientific Company ("Fisher") warrants to the direct purchaser that the Accumet meters and Accumet, AccuTupH, AccuFET, AccupHast, and Microprobe electrodes will be free from defects in material or workmanship for a specified warranty period. During that period, Fisher will repair or replace the product or provide credit, at its sole option, upon prompt notification and compliance with its instructions. Warranties listed below are from delivery date.

WARRANTY FOR METER

For Display: 12 months
For All Other Meter Components: 36 months

WARRANTY FOR ELECTRODES & PROBES

For electrode models 13-620-532 to 13-620-539: 6 months
For other electrode models: 12 months

Unless otherwise agreed, the warranty is limited to the country in which the product is sold.

No Fisher employee, agent or representative has the authority to bind Fisher to any oral representation or warranty concerning any product sold. Any oral representation or warranty made prior to purchase of any product and not set forth in writing and signed by a duly authorized officer of Fisher shall not be enforceable by the purchaser.

FISHER EXPRESSLY DISCLAIMS ALL OTHER WARRANTIES, EXPRESS OR IMPLIED, INCLUDING THE IMPLIED WARRANTY OF MERCHANTABILITY AND FITNESS FOR A PARTICULAR PURPOSE.

Fisher's sole responsibility and the purchaser's exclusive remedy for any claim arising out of the purchase of any product listed above is repair, replacement or credit as described above, where applicable. In no event: 1) shall the cost of the exclusive remedy exceed the purchase price; 2) shall Fisher be liable for any special, indirect, incidental, consequential, or exemplary damages, howsoever arising, even if Fisher has been advised of the possibility of such damages.

Each article that Fisher furnishes will conform to the written specifications given in this manual, or those of a further improved model. Changes are made often to the information in the manual and will be incorporated into future editions.

Notice of Compliance

WARNING: This meter generates, uses, and can radiate radio frequency energy. If not installed and used properly, that is in strict accordance with the manufacturer's instructions, it may cause interference to radio communications. It has been tested and found to comply with the limits for a Class A computing device pursuant to Subpart J of Part 15 of FCC Rules, which are designed to provide reasonable protection against such interference when operated in a commercial environment. Operation of this equipment in a residential area may cause interference, in which case the user, at his own expense, will be required to take whatever measures may be required to correct the interference.

This product is to be used only as described in the manual. This product is for indoor use only, and must be used in a well ventilated area.

WARNING: To meet or exceed FCC regulations and comply with CE requirements, the Fisher-supplied power supply must be used. Use of a power supply that is not approved by Fisher Scientific may cause safety hazards and/or cause unit to exceed EMC limits and/or damage unit. When using this meter with a computer or printer, a shielded RS232 cable must be used to meet or exceed FCC regulations, and comply with CE Mark requirements.

Appendix: Setting the XL Series Meters User Profiles

XL15, 20, 25, 30, 40, 50 and 60 meters

The XL series meters are equipped with a User Profiles setup or the User Profile Management Application. Setting user profiles saves an individual user unique Setup preferences, calibration data and stored data. The meter can be used without setting a user profile but it will recognize all users as **Default**.

Accessing User Profile Screen

1. Touch **Home** on any measurement or the Mode screen to access the Home screen.
2. Double tap on **AdminUser**. The User Login dialog box will appear.
3. Touch the **User ID** box. The alphanumeric keypad will appear. Key in your User ID or "admin". To set up new users or delete users you must log in using the "admin" user ID. The **BS** key will allow you to backspace to remove a character that was incorrectly entered. Press the **Enter** key.
4. Touch the **Password** box, use the alphanumeric keypad on the screen to key in the password.

NOTE: When entering the User Profiles setups for the first time, use **admin** as the Password. Press the Enter key. The User Login screen will appear with User ID and Password entered.



Touch **Login** to enter the User Profiles screen.

From this screen you can update Password and Company Name information by tapping in the appropriate boxes, if you are logged in as a user. If you are logged in as "Admin" user ID you can add and delete users.

Adding User Profiles

1. After logging in under User ID "**admin**" the User Detail fields will show information for "**Admin**". Touch **Clear** to clear all information from the **User detail** box to enter a new user. You can now begin entering information for new users
2. Touch the **User ID** box; use the alphanumeric keypad on the screen to key in the new User ID. The User ID cannot exceed 10 characters. Press **Enter** key to confirm User ID.
3. Touch the **Password** box; use the alphanumeric keypad on the screen to key in a Password. The Password cannot exceed 12 characters. Press **Enter** key to confirm Password.
4. Touch the **Confirm Password** box; use the alphanumeric keypad on the screen to key in the same password used in step 3. Press **Enter** key to confirm Password.
5. Touch the **Company Name** box; use the alphanumeric keypad on the screen to key in the Company Name. Press **Enter** key to confirm Company name.
6. Touch **Add**, a dialog box will ask "Are you sure, you want to add this user?" Touch **Yes** or **No**. If you touch **Yes**, the new user will be added. If you touch **No**, you may still edit the current user.

NOTE: The administrator has authority to add or delete user names. Users may modify their password and company name only by entering User ID and Password in place of Admin on the User Login screen.

Appendix: Setting the XL Series Meters User Profiles XL15, 20, 25, 30, 40, 50 and 60 meters

Admin User XL60 rel 0.01

User Profiles

User logged in

Select User

User Setting

Apply to current user

Apply to all user

Default Setting

Delete User Data

User detail

User ID

Password

Confirm Password

Company Name

User Group

Add **Delete** **Help** **Clear** **Exit**

Modify

Function Buttons on User Profiles Screen

Touch **Add/Modify** to add or modify the current details.

Touch **Delete** to delete the user, applicable only to the Administrator.

When you touch the **Help** button, information about the current screen appears. This information includes step-by-step instructions for operating the meter from the current screen.

Touch **Clear** to clear all user details.

Touch **Exit** to User Profiles screen.

Touch **Apply to current user** to apply Default Setting or Delete User Data function buttons to current user only.

Touch **Apply to all user** to apply Default Setting or Delete User Data function buttons to all users.

Touch **Default Setting** to reset current or all users to factory default setting of meter

Touch **Delete User Data** to delete all measurement data for current or all users.

Appendix: Setting the XL Series Meters User Profiles

XL15, 20, 25, 30, 40, 50 and 60 meters

Once you add a User Profile, the **User Login** dialog box will automatically pop-up when you turn on the meter. You must either log in with the correct password or log in as a Default user. The Default user does not require a password.

User Login

1. When the meter is turned on the **User Login** box will appear on the Home screen.
2. Select a User ID
3. Touch the **Password** box, use the alphanumeric keypad on the screen to key in the password. The **BS** key will allow you to backspace to remove a character that was incorrectly entered. Press the **Enter** key.

NOTE: If you selected Default as a User ID, you do not need to enter a password.

Touch **Login**, the meter enters the measurement mode.

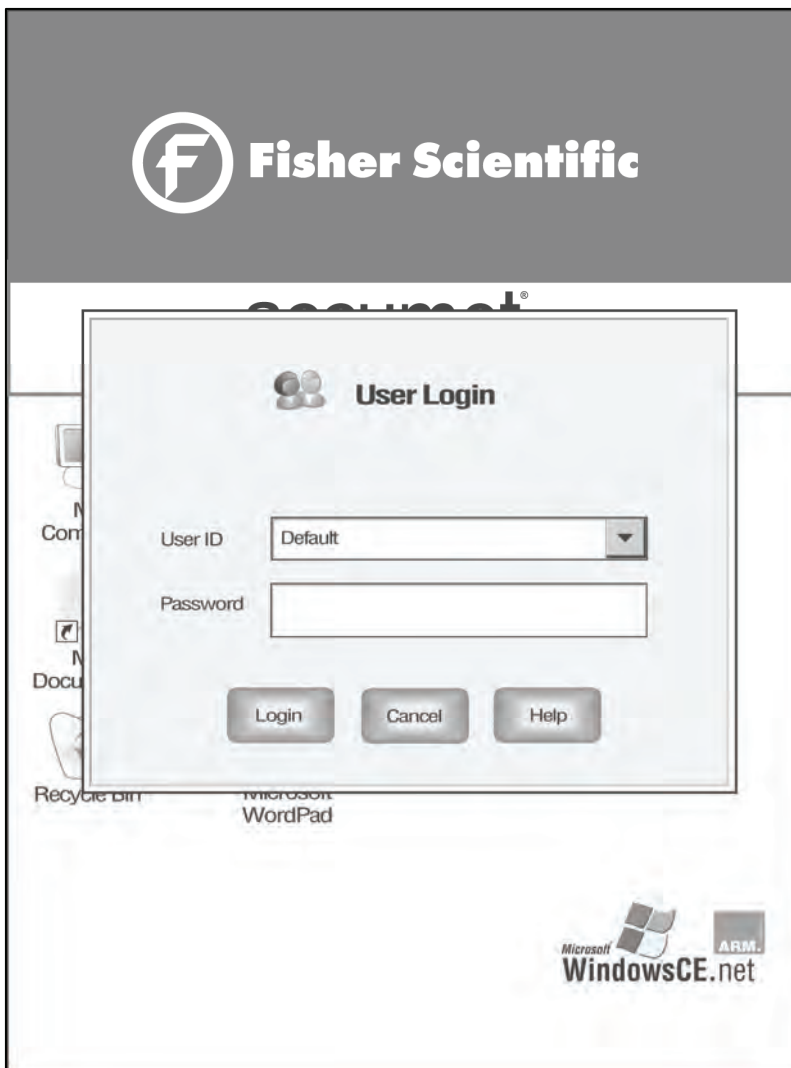

Appendix: XL Series Meters Factory Default Settings

XL15, 20, 25, 30, 40, 50 and 60 meters

The following is a list of XL series meters factory default settings. Reset your meter to the factory default settings by accessing the **Reset to Factory Defaults** from the System Setup screen.

	Screen	Default Setting	XL15	XL20	XL25	XL30	XL40	XL50	XL60
PH SETUP MODE	Display Configuration	All parameters ON	●	●	●			●	●
	Print Configuration	All parameters ON	●	●	●			●	●
	Data Configuration	All parameters ON	●	●	●			●	●
	Buffer Group	USA	●	●	●			●	●
	Sample ID	MANUAL	●	●	●			●	●
	Isopotential Point	0.0 mV	●	●	●			●	●
	Print Interval	LOG DATA	●	●	●			●	●
	Display Resolution	X.XX	●	●	●			●	●
	Buffer Recognition	AUTO	●	●	●			●	●
	Auto Read Mode	MANUAL	●	●	●			●	●
	Temperature Units	C (Celsius)	●	●	●			●	●
	Default Temperature	25.0 C	●	●	●			●	●
	Stability Criteria	FAST	●	●	●			●	●
	Alarm Limits	OFF	●	●	●			●	●
	Alarm Limit Low	-2.00 pH	●	●	●			●	●
Alarm Limit High	20.00 pH	●	●	●			●	●	
mV SETUP MODE	Display Configuration	All parameters ON	●	●	●			●	●
	Print Configuration	All parameters ON	●	●	●			●	●
	Data Configuration	All parameters ON	●	●	●			●	●
	Sample ID	MANUAL	●	●	●			●	●
	Print interval	LOG DATA	●	●	●			●	●
	Display Resolution	X	●	●	●			●	●
	mV Readings	Absolute mV	●	●	●			●	●
	Alarm Limits	OFF	●	●	●			●	●
	Alarm Limit Low	-2000 mV	●	●	●			●	●
	Alarm Limit High	+2000 mV	●	●	●			●	●

Appendix: XL Series Meters Factory Default Settings

XL15, 20, 25, 30, 40, 50 and 60 meters

	Screen	Default Setting	XL15	XL20	XL25	XL30	XL40	XL50	XL60
ION SETUP MODE	Display Configuration	All parameters ON			●			●	●
	Print Configuration	All parameters ON			●			●	●
	Data Configuration	All parameters ON			●			●	●
	Sample ID	MANUAL			●			●	●
	Isopotential Point	0.0 mV			●			●	●
	Print Interval	LOG DATA			●			●	●
	Display Resolution	3 Significant digits			●			●	●
	Auto Read Mode	MANUAL			●			●	●
	Temperature Units	C (Celsius)			●			●	●
	Default Temperature	25.0°C			●			●	●
	Stability Criteria	FAST			●			●	●
	Ion method	Direct Reading with Standards			●			●	●
	Measurement Unit	ppm			●			●	●
	Electrode Type	AMMONIA			●			●	●
	Alarm Limits	OFF			●			●	●
	Alarm Limit Low	10.00 x 10 ⁻⁷			●			●	●
	Alarm Limit High	9.99 x 10 ¹⁰			●			●	●
	DO / BOD / OUR / SOUR SETUP MODE	Display Configuration	All parameters ON					●	
Print Configuration		All parameters ON					●		●
Data Configuration		All parameters ON					●		●
Sample ID		MANUAL					●		●
Calibration Mode		AUTO, One Point					●		●
Print Interval		LOG DATA					●		●
Display Resolution		X.X					●		●
Temperature Units		C (Celsius)					●		●
Stability Criteria		FAST					●		●
Alarm Limits		OFF					●		●
Alarm Limit Low		0.00					●		●
Alarm Limit High		600.00					●		●
DO		Measurement Units	% Sat					●	
	Auto Read Mode	MANUAL					●		●
BOD	Measurement Units	mg/L					●		●
	Seed Min Delta DO	2.0					●		●
	Seed Min DO Endpoint	1.0					●		●
	Sample Min Delta DO	2.0					●		●
	Sample Min DO	1.0					●		●
OUR (SOUR)	Measurement Units	mg/L					●		●
	Dilution Factor (1 to X)	1					●		●
	Minimum Time (min)	1					●		●
	Maximum Time (min)	1 for OUR; 15 for SOUR					●		●
	Minimum Starting DO	5					●		●
	Minimum Ending DO	2					●		●
	Solids Weight (g/L)	1 (SOUR only)					●		●

Appendix: XL Series Meters Factory Default Settings

XL15, 20, 25, 30, 40, 50 and 60 meters

	Screen	Default Setting	XL15	XL20	XL25	XL30	XL40	XL50	XL60
COND / RES / TDS / SAL Setup Modes	Display Configuration	All parameters ON		●		●		●	●
	Print Configuration	All parameters ON		●		●		●	●
	Data Configuration	All parameters ON		●		●		●	●
	Sample ID	MANUAL		●		●		●	●
	Calibration Points	Single Point		●		●		●	●
	Print Interval	LOG DATA		●		●		●	●
	Stable Indicator	ON		●		●		●	●
	Cell Constant	1.000/cm		●		●		●	●
	Temperature Units	C (Celsius)		●		●		●	●
	Default Temperature	25 degree Celsius		●		●		●	●
	Reference Temperature	25 degree Celsius		●		●		●	●
	Temperature Coefficient	2.100% per degree		●		●		●	●
	Alarm Limits	OFF		●		●		●	●
	COND	Conductivity Standards	84 uS, 1.413 mS, 12.88		●		●		●
Standard Recognition		AUTO		●		●		●	●
Alarm Limit Low		0uS		●		●		●	●
Alarm Limit High		500000uS		●		●		●	●
RES	Alarm Limit Low	3.000 Ohm		●		●		●	●
	Alarm Limit High	100.000 MOhm		●		●		●	●
TDS	TDS Factor	0.60		●		●		●	●
	Alarm Limit Low	0 ppm		●		●		●	●
	Alarm Limit High	300000 ppm		●		●		●	●
SAL	Alarm Limit Low	0.000 ppt		●		●		●	●
	Alarm Limit High	90.000 ppt		●		●		●	●

Appendix: XL Series Meters Print Function

XL15, 20, 25, 30, 40, 50 and 60 meters

- ☞ Kindly note that the XL meter functions **only** with printers that features **PCL 5e** (printer command language 5 enhanced) language. Host-based printer with **PCL 5e** language relies on the computer's processor to generate printable pages. **Non PCL 5e** language printer triggers XL meter to modify its internal register and **can cause the meter to crash**.

The XL series meter allows you to send data to the selected **PCL 5e Laser** or **HP LaserJet 1022n** through the **USB-A** port located at the back panel of the XL series meter.

To print using USB-A

1. Power on the XL Series meter and go to single measurement mode.
2. Connect HP printer to **USB-A** port on the back of the XL Series meter.
3. Enter **Sample ID**.
4. Tap **Log data** Icon.
5. On the Measure screen, touch **Print** to initiate the print function.
6. The Print dialog box is displayed on the screen.
7. Select the correct printer using the **Printer** drop down box selection.
8. Set the **Port** drop down box selection to **LPT1**.
9. Make all other selections as needed and then touch **OK** to start sending data.

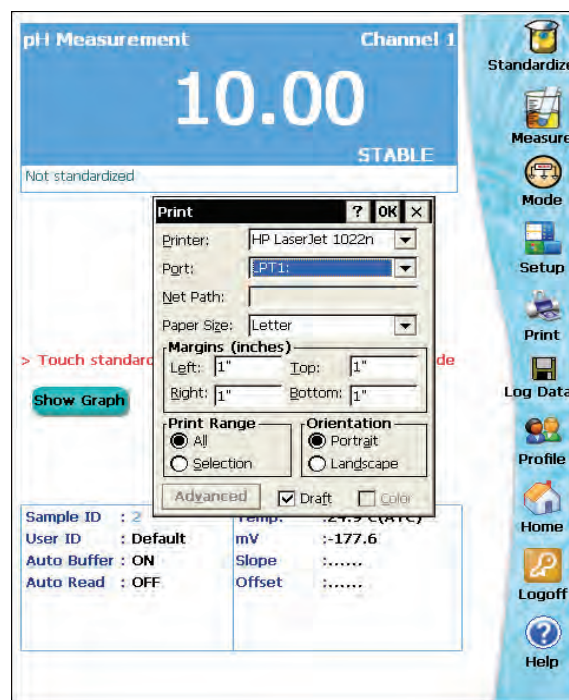
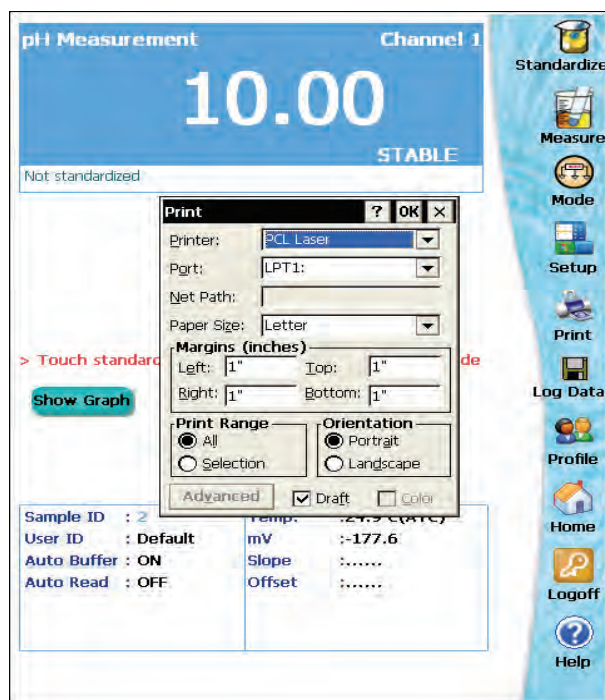

Print icon will appear only in single channel measurement mode.

When a **HP 1022** printer is connected to XL Series meter, you can select either **PCL Laser** or **HP LaserJet 1022n** and port **LPT1** from the print dialog box as shown in above diagrams.

Appendix: XL Series Meters Print Function

XL15, 20, 25, 30, 40, 50 and 60 meters

To print using IrDA (Infrared) port

1. Power on the XL Series meter and go to single measurement mode.
2. Align the IrDA port on the back of the XL Series meter with the IrDA port on the printer to establish link.
3. On the Measure screen, touch **Print** to initiate the print function.
4. The print dialog box is displayed on the screen.
5. Select the correct printer using the **Printer** drop down box selection.
6. Set the **Port** drop down box selection to IrDA.
7. Make all other selections as needed and then touch **OK** to start sending data.

Ensure that the **Draft Box** in the Print dialog box is always checked to avoid improper printing.

NOTE: The XL meter should be powered on and be in the measurement mode before the printer is connected to it.

Appendix: Background and Text Color Adjustment

XL 15, 20, 25, 30, 40, 50 and 60 meters

The **Display Color Setting** option in **System Setup** allows you to customize the background and text color that you would like to be displayed on the screen.

To set the background and text color:

Touch the **System Setup** button to access the **Display Color Setting** box.

Touch the **Default Color** button to select the default display color settings for the reading display screen.

Touch the **Custom Colors** button to adjust the background and text color to be displayed on the screen.

Touch the **My Favorites** button to select color setting from your Favorites list.

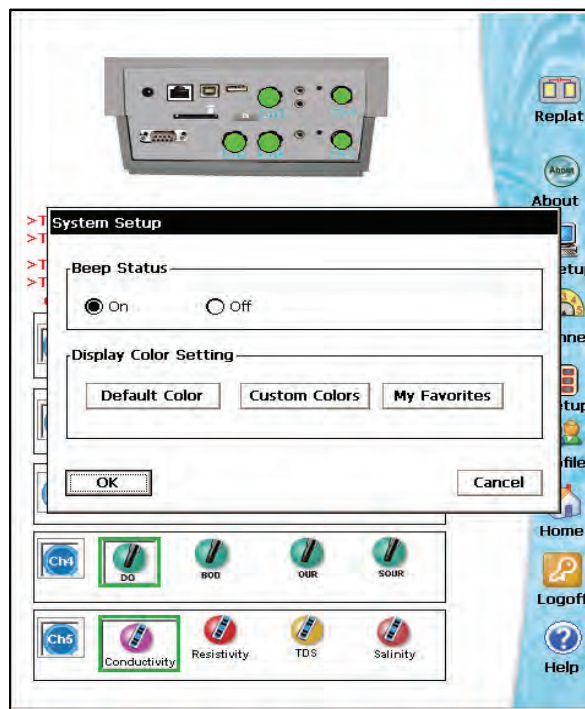

Functions buttons on Custom Display Color Setting Screen:

Touch the **Adjust Background Color** to define the background color for your screen from the Basic colors box.

Touch the **Adjust Text Color** to select the color of the text from the Basic colors box.

Once you have defined the color you want, Touch **Apply & Close** button to apply the selected settings.

Touch the **Add to Favorites** button to include current selected background and text color into your Favorites list.

Touch **Back** button to go to System Setup box.

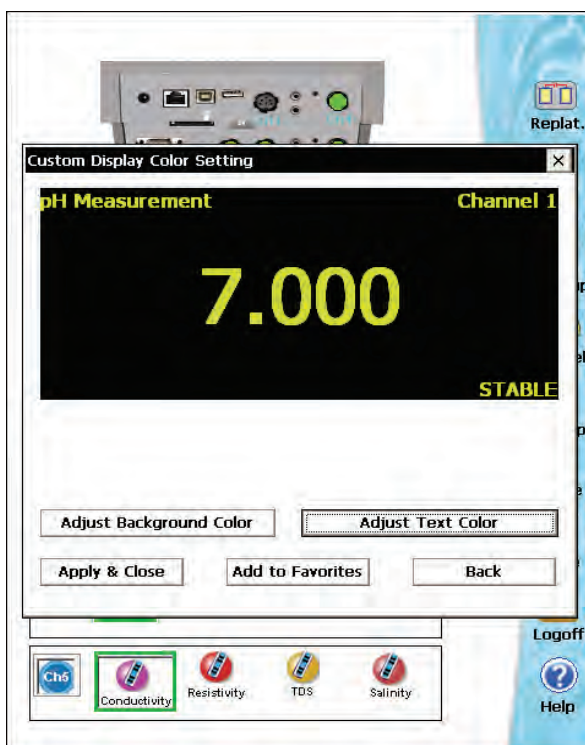

See next page to assign name to your setting and to select setting from **My Favorites** list.

Appendix: Background and Text Color Adjustment

XL 15, 20, 25, 30, 40, 50 and 60 meters

To assign name to your background and text setting and to include it into your My Favorites list

From the Custom Display Color Setting Screen, touch the **Add to Favorites** button to assign name to your selected background and text color.

Type a name for your current selected background and text color and touch **Enter** to include it into your **My Favorites** list.

The assigned **Setting ID** will be listed in **My Favorites Color Setting** box.

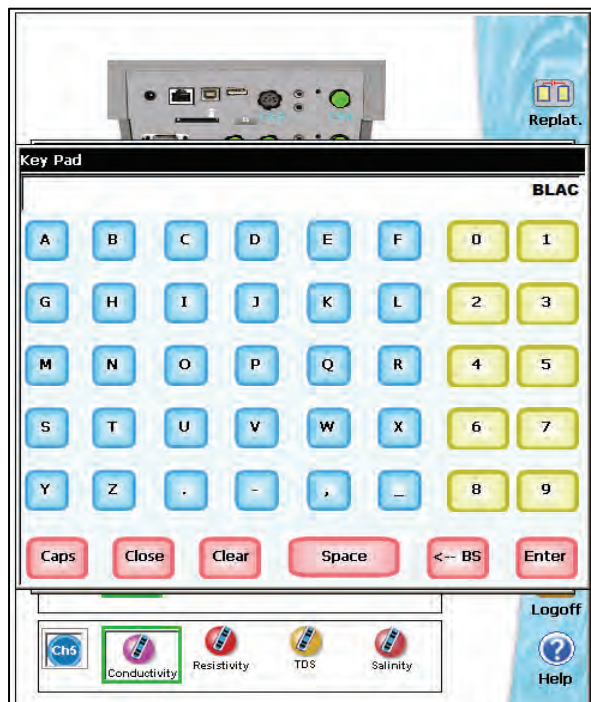

Functions buttons on My Favorites Color Setting Screen

My Favorites Color Setting box displays all the background and text settings that have been saved by the user.

To select setting from Favorites list tap **My Favorites** button. Click the **Setting ID** that you want to use from the **My Favorites Color Setting** box and tap **Apply & Close** button to apply the settings.

To delete setting from the Favorites list, click the **Setting ID** and tap **Delete Setting** button.

Touch **Back** button to go to System Setup box.

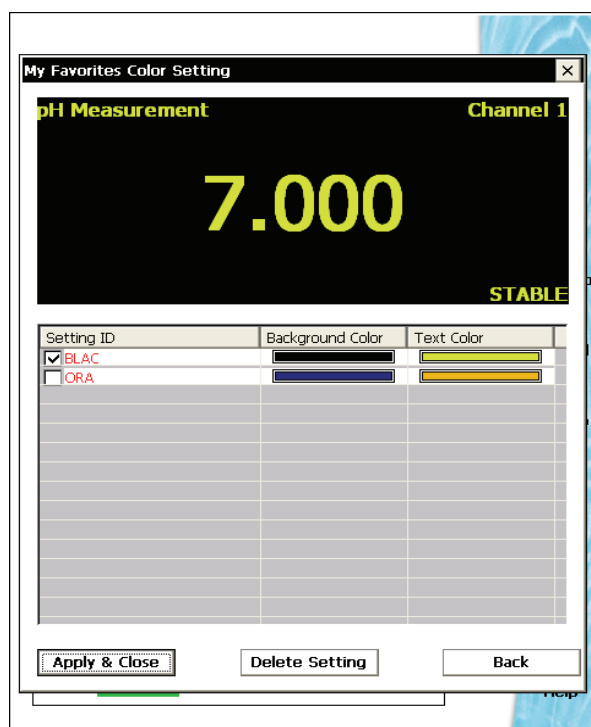

Appendix: Determining Isopotential Points Experimentally

XL15, 20, 25, 50 and 60 meters

The isopotential point of an electrode system is the point at which electrode potential is unaffected by a change in temperature. The coordinates of this point would be reported as (pX_{iso}, E_{iso}) . For an ideal system, this point would be coincident with the system's Zero Potential Point (pX_{iso}, E_0) .

In practical systems, however, this coincidence rarely occurs, and for some systems, there is no true Isopotential Point but a general Isopotential area. If a system exhibits an apparent Isopotential Point, or at least an Isopotential area with relatively small spread, Isopotential coordinates may be established and possibly used to some advantage. Isopotential correction may be used only in conjunction with a One- or Two- Point Standardization; it is required only when both accuracy over a significant temperature range as well as operation with an asymmetric electrode system are contemplated. However, Isopotential correction is never necessary if all measurements will be performed on samples which are at similar temperatures. Most conventional pH electrode systems are designed and manufactured to be highly symmetrical cells. Consequently, for most pH work, unless ultimate accuracy over broad temperature ranges is required, Isopotential may be ignored. Specifically, this is accomplished by setting the Isopotential at its reset value of zero millivolts.

The following is an example for determining an Isopotential Point:

Data points are first established for three different standards at three different temperatures. The data points are then plotted and will produce three isotherms which should resemble the plot in either figure 1 or figure 2. In figure 2, the Isopotential Point is well defined as the intersection point of the three Isotherms (pX_{iso}, E_{iso}) . The Isopotential Point is not so well defined in figure 1, but a value may be interpolated with some accepted error.

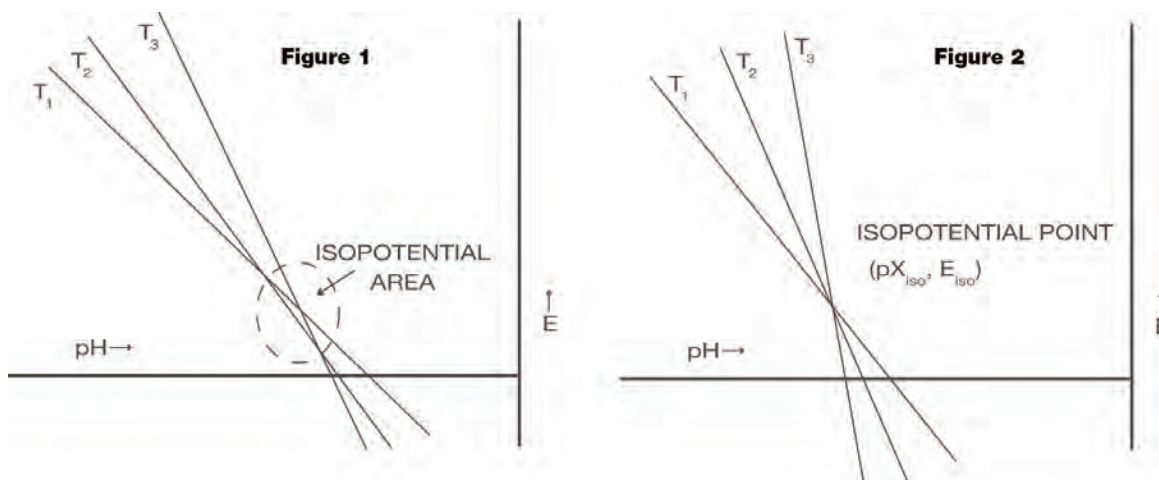

Appendix: pH Theory

XL15, 20, 25, 50 and 60 meters

Since its introduction by the Danish chemist Sorensen in 1909, pH measurement has become one of the most commonly used and important measurements in both laboratory and industrial settings. pH measurement and control is vital to a wide array of endeavors including municipal and industrial wastewater treatment, and textile, pharmaceutical, food, and petroleum production. Even our very existence itself is dependent upon pH. Most organisms can exist only within a narrow pH range. In humans, for example, the pH of blood must be maintained within the pH range of 7.3 to 7.4.

In general, pH is a measure of the degree of acidity or alkalinity of a substance. It is related to the effective acid concentration ("activity") of a solution by this defining equation:

$$\text{pH} = -\log a_{\text{H}_3\text{O}^+}$$

with a H_3O^+ representing the activity or effective concentration of the hydronium ion in solution.

Analysts traditionally work with concentration units rather than activity. Therefore neglecting activity, pH can be defined by the following equation:

$$\text{pH} = -\log [\text{H}_3\text{O}^+]$$

with $[\text{H}_3\text{O}^+]$ representing the concentration in Moles/liter of the hydronium ion in solution.

The pH range includes values from 0 to 14. Values from 0 to 7 represent the acidic half of the scale. Values from 7 to 14 represent the alkaline or basic half of the scale. The pH value 7 is considered neutral, as it is neither acidic or alkaline.

The pH scale is based on the dissociation constant of water. Water, even in its purest state, dissociates as follows producing a positively charged hydronium ion (H_3O^+) and a negatively charged hydroxyl ion (OH^-):

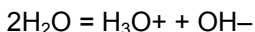

Appendix: pH Theory

XL15, 20, 25, 50 and 60 meters

At 25°C in pure water, the concentration of hydronium ions is extremely small, 1×10^{-7} Moles/liter, and balanced by an equal concentration of hydroxyl ions. The equilibrium constant, K_w of water is the product of the hydronium ion and hydroxyl ion concentrations:

$$K_w = [H_3O^+] [OH^-] = [1 \times 10^{-7}] [1 \times 10^{-7}] = 1 \times 10^{-14}$$

Since the hydronium ion concentration is 1×10^{-7} Moles/liter, the pH of pure water is 7, the neutral pH, as stated above:

$$pH = -\log [1 \times 10^{-7}] = 7$$

In aqueous solutions at 25°C, the product $[H_3O^+] [OH^-]$ or the K_w of water must remain constant. Therefore, an increase in concentration of either term, $[H_3O^+]$ or $[OH^-]$, will result in a decrease in the other. For example, if a strong base, sodium hydroxide (NaOH) is added to water to the extent that its final concentration is 0.01 Moles/liter, the concentration of the OH^- ion is 0.01 Moles/liter, and the concentration of the H_3O^+ must decrease according to the K_w equation as follows:

$$[H_3O^+] = K_w / [OH^-] = 1 \times 10^{-14} / 1 \times 10^{-2} = 1 \times 10^{-12}$$

The pH of this solution is:

$$pH = -\log [1 \times 10^{-12}] = 12$$

This high pH indicates that the 0.01 M NaOH solution is strongly alkaline; the concentration of hydronium ions is extremely small.

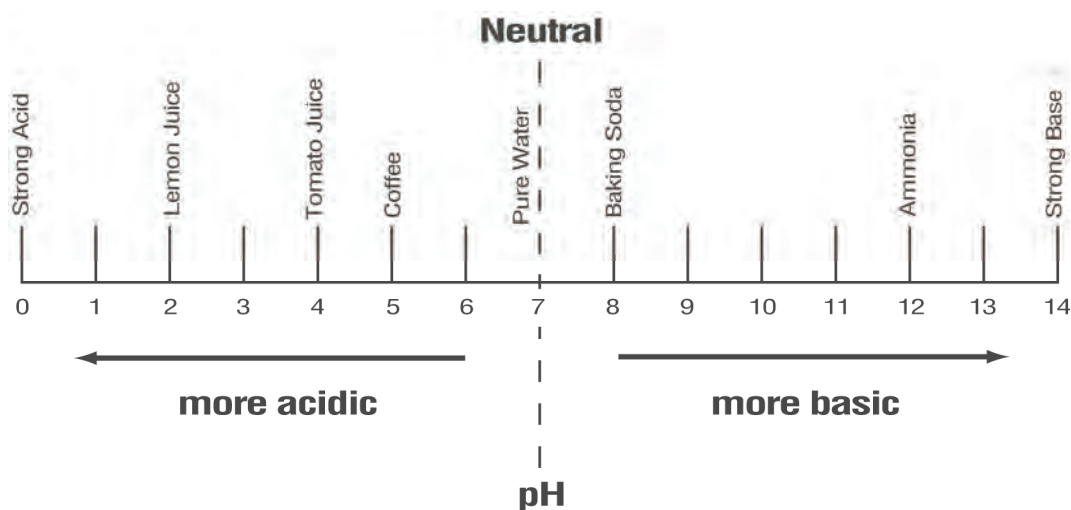

Appendix: pH Theory

XL15, 20, 25, 50 and 60 meters

pH Measurement

The pH value of a sample can be determined in several ways. These include the use of organic dyes which change color in certain pH ranges. The dyes can be added directly to the solution or impregnated onto paper which may be dipped into the solution. At best, these "colorimetric" methods yield approximate pH values, often with an accuracy of plus or minus 0.5 pH units.

The preferred and most accurate way to measure a pH value is the potentiometric measurement, using a pH electrode, a reference electrode, and a pH meter. This method is based on the fact that certain electrodes, immersed in solution, produce a millivolt potential (i.e. voltage) that is related to the hydronium ion concentration or pH of a solution in a precise way.

The relationship between the electrode's voltage and the solution pH is defined by the Nernst equation:

$$E_{meas} = E^* - \left(\frac{2.3RT}{nF} \right) (\text{pH})$$

In this equation, E_{meas} is the voltage output of the electrodes, E^* is the total of all other voltages in the system including the reference voltage, R is the Gas Law constant, T is the temperature in °Kelvin, n is the charge on the hydronium ion (+1), and F is the Faraday constant.

pH Meter

The pH meter is a sensitive voltmeter capable of accurately measuring small voltage differences between the pH electrode and the reference electrode. This voltage difference is amplified, and shown as a pH reading. Almost all modern meters are microprocessor controlled, and programmed to use electrode voltages, efficiency, and temperature to calculate an accurate pH for the sample. Since the voltage output from different electrodes will vary, it is essential to calibrate a pH meter. The ability to calibrate or to standardize a pH meter permits the meter to match the pH reading on the meter with the known pH value of a buffer solution. For best accuracy, it is recommended that at least two buffer solutions be used to calibrate a pH meter. Buffer solutions are available as ready-to-use solutions, concentrated solutions, capsules, or prepackaged salts.

The following table lists three of the most widely used NIST buffers along with their pH values at different temperatures.

Temperature (C)	4.01	6.86	9.18
0	4.003	6.984	9.464
10	3.998	6.923	9.332
20	4.002	6.881	9.225
25	4.008	6.865	9.180
30	4.015	6.853	9.139
40	4.035	6.838	9.068
50	4.060	6.833	9.011



Appendix: pH Theory

XL15, 20, 25, 50 and 60 meters

pH Electrodes

The electrode system consists of two half cells: a pH indicating electrode, which is primarily responsive to the acidity (the hydronium ion concentration) of a solution, and a reference electrode, which provides a constant voltage and completes the electrical circuit.

Traditional pH indicating electrodes use a tip made of pH sensitive glass. Inside this electrode is a buffer solution with a fixed pH and ionic strength. A silver wire coated with silver chloride is immersed inside this internal solution, and establishes electrical contact between the solution and the meter. The voltage associated with this wire and the voltage associated with the pH of the internal solution and the inside wall of the pH sensitive glass tip remain constant. Therefore, changes in voltage from this electrode result from the voltage developed between the solution and the outside of the glass tip.

If the pH sensitive glass tip or membrane is to function properly, it must be hydrated. A dry or dehydrated electrode membrane will not respond properly to changes in acidity. pH electrodes are also effected by changes in temperature, and the presence of other ions. Temperature effects can be countered by temperature compensation functions on the pH meter. While temperature compensation will not allow you to predict what the pH of the sample is at another temperature, it will permit you to accurately assess the pH at whatever temperature you are presently working. pH sensitive membranes are also sensitive, though to a lesser extent, to other ions than the hydronium ion. For example, most pH glasses are somewhat sensitive to sodium ion as well. For some pH glasses, this means an error as high as 0.5 pH units in highly alkaline, high-sodium solutions. The special FS-5 glass used in Fisher's pH electrodes exhibits much less sodium error in these solutions, <.05 pH units.

Reference electrodes typically consist of three elements: an internal reference electrode, a filling solution, and a reference junction through which the filling solution can "flow", and provide electrical contact with the sample and the internal reference electrode. The most convenient internal reference electrodes are made from a metal (such as silver or mercury) and its sparingly soluble salt (silver chloride or mercurous chloride). The filling solution is most often a concentrated solution of potassium chloride. Most problems with reference electrodes are associated with the interruption or blockage of flow of the potassium chloride fill solution through the reference junction.

The classic electrode pair, separate pH indicating and reference half cells, offer you unmatched versatility to match the needs of your sample. This approach makes for the highest accuracy, as well as low replacement costs, since usually only one of the pair is broken or malfunctioning.

However, the pH indicating half-cell and the reference half-cell can be merged into one electrode: a combination electrode. Combination electrodes are quite popular for they offer distinct advantages in convenience and compactness. Some combination electrodes also incorporate an ATC probe into their body also, providing temperature readout and compensation with meters equipped with these features. Newer combination electrodes are available in which the glass pH membrane sensor has been replaced with a field effect transistor or FET. All of Fisher Scientific's AB, AR and XL meters are capable of using this type of electrode by direct connection (except AB30).

Appendix: ISE Theory

XL25, 50 and 60 meters

Ion selective electrodes (ISE) respond to ionic activity or concentration in a liquid because of the characteristics of the electrode's sensing membrane. Ideally, the ISE develops an electrical potential which is proportional to the activity or concentration of the ion for which the membrane is selective. For example, the fluoride electrode can be used to directly sense fluoride ion in drinking water. Analyses utilizing ion selective electrodes offer the advantages of speed, ease-of-operation, low cost, and versatility over other analytical techniques. The ISE can measure the ion concentration of samples at very high levels (> 1000ppm) to very low levels (< 1ppm).

When an ISE, the indicator electrode, and a reference electrode are placed in a solution, and connected to a pH/mV/ion meter, they form a potentiometric cell. At equilibrium, the meter measures the potential difference between the ISE and the reference electrode. This millivolt potential is proportional to the activity of the ion of interest, and the relationship is defined by the Nernst equation:

$$E = E^* \pm 2.3 \frac{RT}{nF} (\log a) \quad \text{where}$$

E is the measured potential

E* is the sum of the standard potential and all other constant potentials of the system

R is the gas constant

T is the temperature in °K

F is Faraday's constant

n is the valence of the ion being measured

Activity, *a*, is not the same as concentration. It is a thermodynamic function whose value is influenced by the ionic environment in which the ion exists. Activity and concentration are the same in very dilute, ideal solutions. In non-ideal solutions, activity and concentration are related by an "activity coefficient".

ISEs sense the activity of free, uncomplexed ions rather than concentration. However, by calibrating the meter with standards with a similar ionic back-ground as the sample, the difference between activity and concentration becomes negligible. Most often this is achieved by adding an ionic strength adjustor to both samples and standards. The Nernst equation becomes:

$$E = E^* \pm 2.3 \frac{RT}{nF} (\log c) \quad \text{where}$$

c is the concentration of the ion of interest.

Appendix: ISE Theory

XL25, 50 and 60 meters

This form of the Nernst equation states that the electrode potential varies directly with the log of the concentration in straight line manner, and results are then expressed in the preferred concentration units. The slope of the line is equal to the value of:

$$\text{Slope} = S = 2.3RT/nF$$

The table below gives theoretical slope values at 25°C.

Species	Slope (mV/decade)	Species	Slope (mV/decade)
Monovalent cation	+59.16	Divalent cation	+29.58
Monovalent anion	-59.16	Divalent anion	-29.58

The Nernst equation thus reduces to:

$$E = E^* + S [\log c]$$

Ion-selective Analysis Methods

Direct Analysis

In this method, a sample concentration is determined by measuring the electrode potential and comparing to those obtained in standard solutions. Normally, an ionic strength adjustor and/or pH adjustor must be added to both the samples and the standards. This helps in that the closer the standard solution matrix is to the sample matrix, the more valid is the analysis. A number of standard solutions are used to standardize a pH/mV/ion meter, or to construct a calibration curve (by plotting the electrode's output in mV versus the log of the concentration). The sample concentration is then read from the meter or the calibration curve.

The advantages of the direct method of analysis are:

1. Many samples (particularly those with relatively simple ionic backgrounds) can be quickly measured after a single calibration procedure.
2. The technique is valid over a wide range of concentrations.
3. Sample volume values are not required, and may also vary over a wide range.

Appendix: ISE Theory

XL25, 50 and 60 meters

Incremental Methods

These procedures can reduce errors caused by temperature variations, complex matrices, and complexation. They are also useful for applications where only occasional samples are analyzed. Incremental methods include: Known Addition, Known Subtraction, Analyte Addition, and Analyte Subtraction.

Known Addition and Known Subtraction

With the Known Addition and Known Subtraction methods, the initial millivolt output of the electrode in the sample solution is measured. Then an aliquot of standard solution is added, and a final millivolt potential is measured. The concentration of the sample can then be computed from the observed change in the millivolt readings before and after the addition. The techniques differ in that with Known Addition the standard added is the same ionic species as that being measured. With Known Subtraction, the measured ion is not the same as the one being added via the standard. For example, a chloride ISE can be immersed in sample for a chloride measurement. If a silver standard is added to the sample, AgCl precipitates, effectively removing or subtracting chloride ion from the sample.

Equations for known addition and known subtraction calculations are as follow:

Known Addition

$$C_s = \frac{C_{std} V_{std}}{(V_s + V_{std})10^{\Delta E/S} - V_s}$$

Known Subtraction

$$C_s = \frac{C_{std} V_{std}}{V_s - (V_s + V_{std})10^{\Delta E/S}}$$

where

C_s is the concentration of the sample; C_{std} is the concentration of the standard; V_s is the sample volume; V_{std} is the standard volume; ΔE is the difference in millivolt readings from the electrode; and S is the slope of the electrode determined in a previous standardization.

Whereas the direct method is suitable for samples with fairly uncomplicated ionic matrices, the addition methods are advantageous with samples that have complex matrices, samples in which no ISA is added, samples in which excess complexing species are present, and samples whose concentration is in the non-linear region on the electrode response curve.

Appendix: ISE Theory

XL25, 50 and 60 meters

Analyte Addition and Analyte Subtraction

In the Analyte methods, the initial millivolt reading is taken with the electrode immersed in the standard; then an aliquot of sample is added, and the final millivolt reading is taken. Sample concentration is calculated from the change in the millivolt readings.

Analyte Addition

$$C_s = C_{std} \left[\left(\frac{V_s + V_{std}}{C_{std}} \right)^{10^{\Delta E/S}} - \left(\frac{V_{std}}{V_s} \right) \right]$$

Analyte Subtraction

$$C_s = C_{std} \left[\left(\frac{V_{std}}{V_s} \right) - \left(\frac{V_s + V_{std}}{V_s} \right)^{10^{\Delta E/S}} \right]$$

As with known addition, with analyte addition the sample and the standard solution contain the same ion being measured. With analyte subtraction, the ion being measured is in the standard solution, and not in the sample solution. For example, a fluoride standard and a fluoride ISE might be used to measure to aluminum concentration of a sample. When the sample containing aluminum is added to the standard it reduces the measured fluoride content of the standard. The amount of reduction is proportional to the aluminum in the sample.

The analyte methods offer the same advantages as do the addition methods in that they effectively deal with complex samples. A distinct advantage of the analyte subtraction method is that it can be used in cases where an ISE does not exist for a given species, such as aluminum in the example cited.

Appendix: DO Theory

XL40 and 60 meters

Meter Operation

The XL40 and XL60 meter uses the polarographic method of determining dissolved oxygen concentration. A voltage is maintained across two electrodes (a gold cathode and a silver anode) and an electrolyte separated from the sample solution by an oxygen permeable membrane. Oxygen diffuses from the sample across the membrane where it is reduced at the cathode.

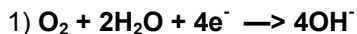

The current generated, I , by such an electrode is proportional to the oxygen concentration of the sample. The rate of oxygen reduction at the cathode is significantly faster than the rate of diffusion to the electrode. Therefore, the rate of oxygen reduction is diffusion limited

$$2) I = kD (\text{O}_2)$$

I is the measured current

k is a proportionality constant

D is the diffusion coefficient of oxygen

Equation 2 is a simplified description of current generated by the oxygen electrode. Many other factors such as electrode surface area, membrane thickness, membrane permeability coefficient, and oxygen partial pressure are integral to this process and incorporated into the constants k and D . As the partial pressure of oxygen in the water is equal to that in the atmosphere, the oxygen partial pressure differential between the sample and the electrolyte inside the electrode is the driving force bringing oxygen to the electrode.

Oxygen Solubility

Oxygen solubility in water is critical parameter in many arenas including biochemistry, industrial processes, and particularly environmental science and engineering. Sufficient dissolved oxygen is an absolute requirement for good water quality. It is essential for aerobic life and the natural purification processes to which they contribute. Dissolved oxygen concentrations below 5 ppm will result in substantial damage to the aquatic ecosystem, and concentrations below 2 ppm can result in fish kills and growth of harmful bacteria.

The ultimate amount of oxygen possible in water is a function of temperature, atmospheric pressure, and the concentration of dissolved salts or salinity. At a given atmospheric pressure, water will hold a fixed, well-defined amount of oxygen at a given temperature. Water at higher temperatures will hold less oxygen than water at lower temperatures.

Dissolved salts in water lower its capacity for oxygen. Though the amount of oxygen that water can hold is reduced by the presence of dissolved salts, the partial pressure of the dissolved oxygen still equals that of oxygen in the air above it. The XL40 and XL60 meter compensates for this fact by relating the salinity value of water to its true capacity for oxygen at a given temperature and pressure.

Biochemical Oxygen Demand (BOD)

The BOD test measures the degree to which water is contaminated with organic material, which is decomposed by aerobic bacterial processes. This test is a critical importance for municipal and industrial discharges. Typically, the sample is diluted with oxygen saturated water. The dissolved oxygen content is measured immediately after dilution, and after a 5-day incubation period. The BOD is expressed as the mg/L of dissolved oxygen consumed during the incubation.

Appendix: Replatinization

XL20, 30, 50 and 60 meters

Replatinization is the process of replacing the platinum on the surfaces of the 2 cell conductivity probes that may flake or wear off over time. The platinum on the surface of the probe is used to increase the surface area of the measuring surface resulting in decreased polarization error. Replatinization is a relatively quick procedure to perform, taking no more than 5 minutes. Although replatinization is not a long process, the replatinization solution is costly. If you are not certain that replatinization will improve the performance of your accumet conductivity probe, please call the technical support hotline at 1-888-358-4706.

To Perform Replatinization

1. Access the Replatinization mode from the Mode screen. In any measuring mode, touch **Mode** to access the Mode screen.
2. Touch **Replat.** to enter the Replatinization mode.
3. Immerse your 2 cell conductivity probe into the replatinization solution. The immersion depth should be enough to cover the vent holes on the probe.
4. Touch **Start** on the display screen to begin the process of replatinization. At this time a countdown timer will appear on the display screen showing the time elapse and time remaining in the replatinization procedure.

Note: At anytime after you have initiated the replatinization:

You can touch **Stop** to stop the procedure

OR

You can touch **Exit** to cancel the replatinization the procedure and return to the Mode screen.

4-cell conductivity probes do not require replatinization.

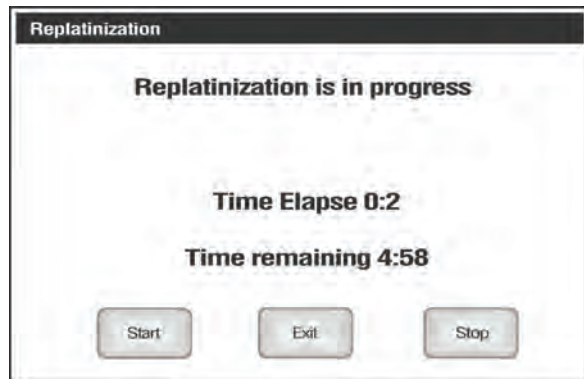

Appendix: Conductivity Theory

XL20, 30, 50 and 60 meters

Conductance is a quantity associated with the ability of primarily aqueous solutions to carry an electrical current, I , between two metallic electrodes when a voltage E is connected to them. Though water itself is a rather poor conductor of electricity, the presence of ions in the water increases its conductance considerably, the current being carried by the migration of the dissolved ions. This is a clear distinction from the conduction of current through metal, which results from electron transport. The conductance of a solution is proportional to and a good, though nonspecific indicator of the concentration of ionic species present, as well as their charge and mobility. It is intuitive that higher concentrations of ions in a liquid will conduct more current. Conductance derives from Ohms law, $E = IR$, and is defined as the reciprocal of the electrical resistance of a solution.

$C = 1/R$ **C** is conductance (siemens)

R is resistance (ohms)

One can combine Ohms law with the definition of conductance, and the resulting relationship is:

$C = I/E$ **I** is current (amps)

E is potential (volts)

In practice, conductivity measurements involve determining the current through a small portion of solution between two parallel electrode plates when an ac voltage is applied. Conductivity values are related to the conductance (and thus the resistance) of a solution by the physical dimensions - area and length - or the cell constant of the measuring electrode. If the dimensions of the electrodes are such that the area of the parallel plates is very large, it is reasonable that more ions can reside between the plates, and more current can be measured. The physical distance between the plates is also critical, as it effects the strength of the electric field between the plates. If the plates are close and the electric field is strong, ions will reach the plates more quickly than if the plates are far apart and the electric field is weak. By using cells with defined plate areas and separation distances, it is possible to standardize or specify conductance measurements.

Thus comes the term specific conductance or conductivity.

The relationship between conductance and specific conductivity is:

Specific Conductivity, S.C. = (Conductance) (cell constant, k) = siemens * cm/cm² = siemens/cm

C is the Conductance (siemens)

k is the cell constant, length/area or cm/cm²

Since the basic unit of electrical resistance is the ohm, and conductance is the reciprocal of resistance, the basic unit of conductance was originally designated a "mho" - ohm spelled backwards - however, this term has been replaced by the term "siemen". Conductivity measurements are reported as Siemens/cm, since the value is measured between opposite faces of a cell of a known cubic configuration. With most aqueous solutions, conductivity quantities are most frequently measured in microSiemens per cm ($\mu\text{S/cm}$) or milliSiemens per cm (mS/cm).

The accumet XL20,30,50 and 60 meter not only measures conductivity readings from micro or milli Siemens but also reads resistivity (Ohms, kOhms and MOhms), TDS (ppm and ppt), and salinity (ppt).

Appendix: Conductivity Theory

XL20, 30, 50 and 60 meters

The salinity scale which ranges from 0 to 90 ppt is a measure of all salts, not just sodium chloride. This scale was originally devised for seawater, and is based on seawater at 15 degrees Centigrade has a conductivity equivalent to that of a potassium chloride solution of a known concentration. This solution (0.44 molal) is defined as having a salinity of 35 ppt.

Note: ppm = parts per million, ppt = parts per thousand, 1000 ppm = 1 ppt

The total dissolved solids scale approximates the ppm TDS in surface waters by multiplying the conductivity of a sample by a factor, 0.66.

Some users prefer the use of resistivity units to describe their water, particularly where high purity water is involved. The unit most often used to describe resistivity is megohm•cm., which is simply the reciprocal of conductivity ($\mu\text{S}/\text{cm}$). The chart below shows the relationship between these units.

Conductivity, $\mu\text{S}/\text{cm}$	Resistivity, megohm. cm
0.056	18.0
0.1	10.0
1.0	1.0
2.5	0.4
10.0	0.1

Conductivity Measurement

accumet conductivity electrodes consist of glass or epoxy bodies in which platinum or platinized sensing elements are fixed. Typically, each electrode has two such sensing elements and are designated two-cell electrodes. The previous discussion has focused on this type of electrode. Four cell electrodes are also available, and the theory and application of these are in a separate section.

These sensors contact the solution whose conductivity value is sought. The exact cell constant of the electrode must be determined prior to measuring the sample. In essence, this is accomplished by fixing the nominal cell constant of the electrode into the meter, and recording the observed conductivity value associated with a standard conductivity solution (usually a KCl solution) with a precisely known value. The following calculation yields the actual cell constant.

$$k = \text{standard value of solution } (\mu\text{S}) / \text{observed value of solution } (\mu\text{S})$$

Fortunately, the accumet XL20, 30, 50 and 60 meter automatically does this calculation for you by touching Standardize.

To produce an appropriate current signal for the meter it is important to choose an electrode with an appropriate cell constant. The following table lists the optimum conductivity ranges for electrodes with cell constants of 0.1, 1, and 10.

Cell Constant	Optimum Conductivity Range, 2-cell
0.1	0.5 to 200 $\mu\text{S}/\text{cm}$
1.0	0.01 to 2 mS/cm
10.0	1 to 200 mS/cm

Prior to use the electrodes should be conditioned in distilled or deionized water for at least 10 minutes or in accordance with the manufacturer's instructions.



Appendix: Conductivity Theory

XL20, 30, 50 and 60 meters

The four-cell electrode

Traditionally, conductivity measurements were made with a “two cell” electrode. This electrode used two metallic sensors, an anode and a cathode to which ions migrated. Under the influence of DC current, the electrodes quickly became polarized. In this situation, molecules formed at the electrode surfaces and ions migrating to the area collect around the respective anode or cathode and actually screen it from other ions. In essence the flow of ions stops, and current ceases to flow. Polarization and associated errors can be minimized by using AC voltage, the appropriate cell constant, and a large electrode surface area. The influence of polarization can also be minimized by the use of a four-cell electrode.

The four cell configuration consists of two cells, an outer cell and an inner cell. Voltage is applied to the sensors of the outer cell, which in turn generates a voltage across the sensors of the inner cell. The inner cell is connected to a high impedance circuit and, unlike the outer cell generates no current. Since no current is generated across the inner cell, polarization cannot occur at the inner cell. By measuring the voltage of the inner cell, which is adjusted to match the reference voltage by increasing or decreasing the current through the inner cell, one obtains a true picture of conductivity minus the influence of polarization.

Cell Constant	Optimum Conductivity Range, 4-cell
0.1	Not Available
1.0	0.01 to 20 mS/cm
10.0	1 to 200 mS/cm

Conductivity and Temperature

Conductivity in aqueous solutions reflects the concentration, mobility, and charge of the ions in solution. The conductivity of a solution will increase with increasing temperature, as many phenomena influencing conductivity such as solution viscosity are affected by temperature.

The relationship between conductivity and temperature is predictable and usually expressed as relative % change per degree centigrade. This temperature coefficient (% change per degree) depends on the composition of the solution being measured. However, for most medium range salt concentrations in water, 2% per degree works well. Extremely pure water exhibits a temperature coefficient of 5.2%, and concentrated salt solutions about 1.5%.

Since temperature effects the conductivity measurement so profoundly, the usual practice is to reference the conductivity to some standard temperature. This is typically 25°C, but the XL20, XL30, XL50 and XL60 meters lets the operator select any value between of 15°C and 30°C in the Setup menu option, set Reference Temperature.

The XL20, XL30, XL50 and XL60 meters permits you to enter the temperature coefficient which best suits your sample and use an ATC probe to automatically temperature compensate back to the chosen reference temperature. Refer to the Setup menu option, set Temperature Coefficient.

Replacement Parts

Replacement Parts

Description	Fisher Catalog Number
accuCap™ refillable electrode, double junction, glass body	13-620-130
Replacement filling solution for 13-620-130 electrode	13-636-430
accumet pH combination electrode, single junction, Ag/AgCl reference, glass body, BNC connector	13-620-285
ATC Probe	13-620-19
accuFlex electrode support arm and base	13-637-671
BNC Shorting cap	13-620-99

pH Accessories

pH Electrode	Fisher Catalog Number
accuCap Glass Body Gel-Filled pH Combination Electrode	13-620-131
accuCap Plastic Body Gel-Filled pH Combination Electrode	13-620-132
accuCap Glass Body Spear Tip pH Combination Electrode	13-620-133
accumet 3-in-1 pH/ATC combination electrode, single junction, Ag/AgCl reference, epoxy body, BNC connector	13-620-530
accumet 3-in-1 pH/ATC combination electrode, Tris-compatible, calomel reference, epoxy body, BNC connector	13-620-531
accuFet XL cone-tip electrode	13-620-700
accuFet XL cup-tip electrode	13-620-710
accuFet XL flat-tip electrode	13-620-720
accuFet XL lance-tip electrode	13-620-730

Calibration Certificate

Fisher Catalog Number

NIST pH meter calibration certificate	15-094-28
---	-----------

pH Buffers and Solutions

pH	Color	Description / Ingredients	Size	Fisher Catalog Number
4.00	Red	Potassium Biphthalate	500 mL	SB101-500
7.00	Yellow	Potassium Phosphate Monobasic	500 mL	SB107-500
10.00	Blue	Potassium Carbonate, Potassium	500 mL	SB115-500
4.00	--	Individual Tear Open pH Packets	20/box	13-300-150
7.00	--	Individual Tear Open pH Packets	20/box	13-300-149
10.00	--	Individual Tear Open pH Packets	20/box	13-300-148

Fisher BufferPac® (pH 4.00, 7.00, and 10.00 buffers), 3 x 500 mL	SB105
Individual Tear open pH Packets assortment (5 each of pH 4.00, 7.00, 10.00 and rinse packets), 20/box	13-300-147
Electrode Rinse Individual Tear open pH Packets, 20/box	13-300-180
Electrode storage solution, 1 L	SE40-1

To place an order, call 1-800/766-7000, fax 1-800/926-1166, or online www.fishersci.com



Fisher Scientific

185

accumet®
excel

Replacement Parts

Dissolved Oxygen Accessories

Description	Fisher Catalog Number
Self-stirring probe	13-620-SSP
DO probe membrane kit, includes 6 replacement caps, polishing disk and electrolyte filling solution	13-637-DOM
Electrolyte filling solution, 500 mL	Na2SO4,KCL
0% zero oxygen calibration solution, 500 mL	00653-00
Adapter, for adapting YSI model 5910 probes to accumet benchtop meters	13-637-DOADPT
Adapter, for adapting YSI model 5905 probes to accumet benchtop meters (also requires adapter 13-637-DOADPT)	13-299-78

BOD Accessories

BOD bottles with robotic stoppers, unnumbered, 300 mL, case of 24	02-926-26
BOD bottles with pennyhead stoppers, unnumbered, 300 mL, case of 24	02-926-7A
Polyseed BOD capsules, pack of 50	02-297-200
Polyseed-NX BOD capsules, pack of 50	02-297-201

To place an order, call 1-800/766-7000, fax 1-800/926-1166, or online www.fishersci.com

Replacement Parts

Conductivity Accessories

Description	Fisher Catalog Number
Conductivity probe storage solution. Keeps probes ideally conditioned and ready for use.....	09-330-1

accumet Immersion Type Conductivity Electrodes

Cell constant	2 Cell Conductivity Cell		4 Cell Conductivity Cell	
	Glass Body	Epoxy Body	Glass Body	Epoxy Body
0.1 cm ⁻¹	—	13-620-101	—	—
1.0 cm ⁻¹	—	13-620-100	13-620-163	13-620-165
10.0 cm ⁻¹	—	13-620-102	13-620-164	13-620-166

accumet Conductivity Calibration Standards

Conductivity	Resistivity	Dissolved Solids	16 oz bottle	100mLx6 bottles
10 µmhos	0.1 megohms	6.6 ppm	09-328-1	09-328-6
100 µmhos	0.01 megohms	66 ppm	09-328-2	09-328-7
1000 µmhos	0.001 megohms	660 ppm	09-328-3	09-328-8
1413 µmhos	0.0007 megohms	933 ppm	09-328-11	09-328-12
10,000 µmhos	0.0001 megohms	6600 ppm	09-328-4	09-328-9
100,000 µmhos	0.00001 megohms	66,000 ppm	09-328-5	09-328-10

For a complete selection of electrodes and accessories, please refer to the Fisher Catalog, or contact your Fisher Scientific sales representative.

To place an order, call 1-800/766-7000, fax 1-800/926-1166, or online www.fishersci.com

Note: For electrochemistry technical support, call 1-888-358-4706 or e-mail accumet@thermofisher.com



Replacement Parts

For more information on Eutech Instruments products, contact your nearest Eutech Instruments distributor or visit our website listed below:

Manufactured by:

Eutech Instruments Pte Ltd

Blk 55, Ayer Rajah Crescent,

#04-16/24 Singapore 139949

Tel: (65) 6778 6876

Fax: (65) 6773 0836

E-mail: eutech@thermofisher.com

Web-site: www.eutechinst.com

Distributed by:

68X374204 Rev 6 Dec 07